

A handbook  
for workplaces

---

# Officewise – A guide to health & safety in the office

Edition No. 5  
January 2006



# CONTENTS

<b>Introduction</b> .....	1	<b>5. Working with computers</b> .....	49
Using this guide .....	1	Health effects .....	51
How this guide can help you .....	1	<b>6. General health and safety issues in the office</b> ..	53
<b>1. Managing occupational health and safety in the office</b> .....	2	Specific health and safety issues .....	53
The risk management approach .....	2	Emergency management .....	56
Identifying hazards in the office .....	6	Copying and similar equipment .....	57
Occupational health and safety legislation .....	9	Hazardous substances .....	58
Developing a health and safety policy .....	10	Housekeeping issues in the office .....	59
<b>2. Job design in office work</b> .....	12	<b>Appendices</b> .....	62
Physical factors .....	12	A. Setting up your workstation .....	62
Psychosocial factors at work .....	13	B. Exercises for office workers .....	68
Reducing stress through good job design .....	17	C. Office Safety Checklist .....	72
<b>3. Designing a healthy and safe working environment</b> .....	22	Job design .....	73
Lighting in the office .....	22	Social and psychological issues .....	74
Noise in the office .....	26	Manual handling .....	75
Thermal comfort and air quality in the office .....	29	Environmental factors .....	76
<b>4. Office layout, workstations and equipment</b> .....	32	Office layout .....	78
Office layout and design .....	32	Workstations .....	79
Workstation design .....	33	Office equipment and tools .....	80
Chairs .....	34	Storage .....	81
Desks and workbenches .....	37	Copying equipment .....	82
Data input devices – keyboards, the mouse, and other pointing devices .....	39	Hazardous substances .....	83
Other office equipment .....	40	Electrical hazards .....	84
Different types of office work .....	43	Housekeeping .....	85
Storage and moving systems .....	45	D. References and advice – where to obtain them ..	89
		<b>Subject index</b> .....	95

# INTRODUCTION



Almost every organisation has some office-based work. Technology like data processing, communications and information transfer has enabled an enormous increase in the volume of information handled daily. These changes offer many positive effects through faster communication, greater job satisfaction and increased variety in the tasks performed, but also some negatives like decreased physical variation, information overload, repetition and monotony.

The increase in flexible and portable equipment has also expanded the office environment into areas outside the traditional office such as on-site locations, vehicles and the home. Occupational health and safety practices need to keep pace with the rapid changes in office-based work.

## USING THIS GUIDE

This guide promotes health and safety in the office and is designed as a resource for managers, supervisors and anyone involved in office work. It brings together a range of information and provides references where more information is necessary.

*Officewise: A Guide to Health and Safety in the Office* is based on a risk management approach to office health and safety – a consultative process to identify hazards, assess their risks and control them as far as possible. This approach should be adopted in the design and management of offices, work carried out in them, and the selection and use of furniture and equipment.

## HOW THIS GUIDE CAN HELP YOU

Offices vary from multi-storeyed, air conditioned buildings to small areas that are part of warehouses, factories, hospitals and homes. While hazards in the office may not always be as obvious as those in factories, office workers may also face a range of health and safety issues, including poor job design, prolonged repetitive work, moving heavy loads, inadequate lighting and cramped or unsafe work areas.

*Officewise* is designed to help employers and employees take a look at their workplace. It aims to:

- raise awareness of health and safety issues in the office;
- help identify existing and potential health and safety problems;
- encourage consultation on health and safety issues;
- help employers meet their legal responsibilities in relation to health and safety;
- offer solutions and advice; and
- give guidance on where to go for further information and help.

# 1

## MANAGING OCCUPATIONAL HEALTH AND SAFETY IN THE OFFICE

This section outlines a risk management approach to health and safety in offices. It provides general information about the framework of Victorian occupational health and safety legislation, and how this applies to office environments.

Information about the development and implementation of health and safety policy in the office is also discussed.

### THE RISK MANAGEMENT APPROACH

The aim of occupational health and safety risk management is to eliminate or reduce the risk of injuries and illness associated with work. Managing health and safety in the office requires a process of hazard identification, risk assessment, risk control and evaluation of control measures.

Effective management of health and safety hazards also involves training, consultation, documentation of health and safety activities and regular review of the management system.

Risk management is a continuous process, as technology changes and further options for the control of risks become available. It requires consultation between employers, employees and Health and Safety Representatives when determining the approach and methods to be used.

Employers are also required to provide information, training and supervision so that employees can perform their work in a safe manner.

Training should provide employees and their supervisors with an understanding of:

- health and safety legal responsibilities;
- the nature of the hazards in the workplace;
- the process of hazard identification, risk assessment and risk control;
- the arrangements for reporting;
- circumstances likely to cause hazards;
- the reasons for and safe use of the risk control measures in place in the workplace; and
- safe work practices.

# MANAGING OCCUPATIONAL HEALTH AND SAFETY IN THE OFFICE



Figure 1.1

Employers are also required to keep information and records relating to the health and safety of employees. These include records for legal requirements (for example, injury reports) as well as records of hazard identification, risk assessment and risk control. A review of health and safety enables an organisation to determine whether their health and safety management activities are effective. Policies, procedures and control measures require reviewing over time to ensure that their objectives are being achieved.

## **Why is health and safety risk management important to a business?**

There is a legal obligation to provide a healthy and safe workplace. In addition, effective management of health and safety hazards makes good business sense. It can lead to reduced costs, increased productivity, higher morale and better employee relations.

## **Who is responsible for health and safety?**

Employers have a duty of care to provide a healthy and safe working environment under occupational health and safety legislation and common law (see Appendix D for references). The *Victorian Occupational Health and Safety Act (2004)* states that the 'employer must, so far as is reasonably practicable, provide and maintain for employees of the employer a working environment that is safe and without risks to health' (Section 21(1)). Employees also have obligations under legislation to take reasonable care of the health and safety of themselves and others, and to cooperate with the employer in compliance with the legislation. Designers of plant, buildings or structures also have responsibilities under occupational health and safety legislation. Manufacturers and suppliers of plant and substances used in the office environment also have responsibilities, as do people installing, erecting or commissioning plant.

Employers should ensure that all managers, supervisors and employees are aware of their occupational health and safety responsibilities. This should be done through consultation, documenting responsibilities and ensuring there are processes in place to hold people accountable for occupational health and safety performance.

## **Integrating health and safety into office management**

Systems and processes for the management of health and safety hazards in the office should be built into the day-to-day running of any business. They should be viewed as part of the normal operation of the business.

## **How can this be achieved?**

Occupational health and safety must be managed systematically (see Figure 1.2). The best system will depend on the nature and size of the business, however, there are a number of aspects to be considered as a basis for any sound occupational health and safety management system.

# MANAGING OCCUPATIONAL HEALTH AND SAFETY IN THE OFFICE

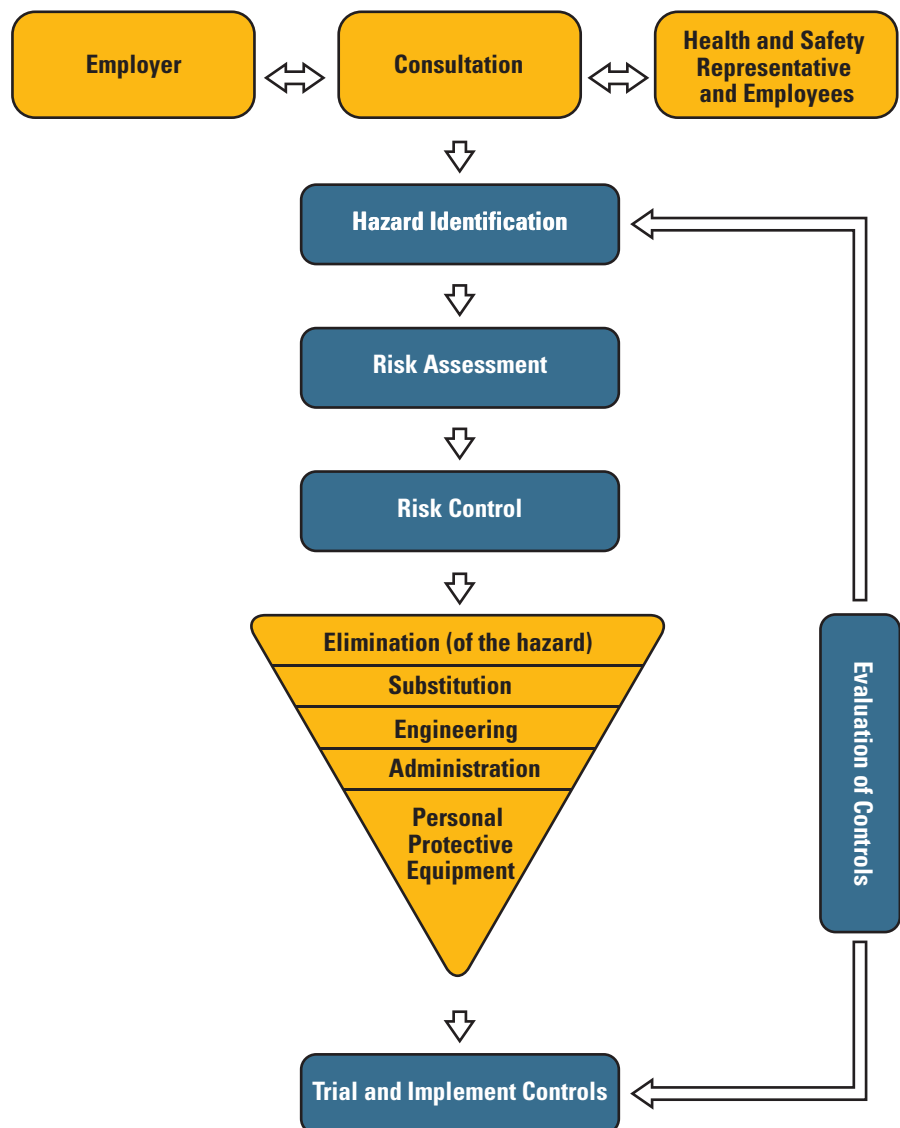

Figure 1.2 The hazard management approach

## Consultation

Consultative arrangements should be in place to enable effective cooperation between the employer and employees in developing and promoting measures to ensure employees' health, safety and welfare at work.

Consultation should involve:

- managers and supervisors representing the employer; and
- employees and elected Health and Safety Representatives (HSR) or other parties representing the employees.

An effective forum for consultation is a health and safety committee. Consultation about specific issues and hazards should include direct discussion with relevant employees.

Further information about health and safety committees and Health and Safety Representatives is found in the legislation.

# MANAGING OCCUPATIONAL HEALTH AND SAFETY IN THE OFFICE

---

## Definitions and processes

**Hazard** means the potential to cause harm (such as injury or illness).

**Risk** means the likelihood of harm arising from exposure to any hazards and the consequences of that harm. For example, cleaning fluids may be a potential hazard but may not pose a risk of exposure unless they are incorrectly stored or handled.

### **Hazard identification**

This is the process of identifying all situations or events that could give rise to injury or illness. It generally involves consideration of the type of injury or illness possible, (for example musculoskeletal disorders (MSD)) and the situations and events that could create potential for the injury or illness (for example, prolonged bending over a low desk during a collating task).

### **Risk assessment**

This process determines whether there are any risks associated with the identified hazards. This generally involves consideration of the nature of exposure to the hazards, including the frequency and level of exposure, pattern of exposure (continuous or intermittent) and adequacy of any existing risk control measures.

### **Risk control**

This process determines and implements appropriate measures to control risk. Factors that are assessed as posing an increased risk are required by legislation to be controlled so far as is 'reasonably practicable'. 'Reasonably practicable' in this case means you need to consider:

- the likelihood of the hazard or risk eventuating;
- the degree of harm that would result if the hazard or risk eventuated;
- what the person concerned knows, or ought reasonably to know, about the hazard or risk and any ways of eliminating or reducing the hazard or risk;
- the availability and suitability of ways to eliminate or reduce the hazard or risk; and
- the cost of eliminating or reducing the hazard or risk.

The objective of the *Occupational Health and Safety Act 2004* is the elimination at source of risks to the health, safety and welfare of persons at work.

If risks cannot be eliminated, occupational health and safety legislation requires that they be reduced so far as is reasonably practicable. You could use one or more of the following methods:

- **substitution** of the hazard with something posing a lower risk;
- **isolation** – for example, enclosing the hazard; or
- **engineering control** – for example, a mechanical aid.

If a risk to health and safety remains after the above methods have been used, administrative controls, for example work procedures and training, should be applied and, if relevant, *personal protective equipment* should be worn.

### **Evaluation of control measures**

This means checking to see whether the introduced changes reduce the risk previously assessed. It may involve repeating the process of hazard identification, risk assessment and risk control to ensure that all risks to health and safety from a particular hazard have been controlled as far as practicable. This depends on the hazard, the nature of the assessed risks and on the control measures used. Where the evaluation of risk control measures reveals some remaining risk, the process continues until risk is minimised as far as reasonably practicable.

# MANAGING OCCUPATIONAL HEALTH AND SAFETY IN THE OFFICE

---

## IDENTIFYING HAZARDS IN THE OFFICE

### Consider the type of hazard present in your office

- Mechanical hazards, such as filing cabinets that tend to tip when heavily laden top drawers are open; tripping hazards.
- Physical hazards, like glare or reflections from screens; hot components of photocopiers; poorly designed chairs that do not provide the user with adequate back support; poorly designed jobs and tasks that demand prolonged work in a fixed posture.
- Chemical hazards, such as vapours in the atmosphere – for example, paint, solvents or airborne particles like photocopier toner.
- Psychological hazards, like the need to perform excessive workloads under pressure, lack of satisfaction from a job where there is inadequate recognition of work performed or repetitive work and insufficient task variety.
- Electrical hazards such as damaged electrical cords or overloaded power points that may lead to the risk of electric shock.

Each of these hazards is discussed in more detail in other sections of this guide.

### Check records of injuries and incidents

In Victoria, the *Occupational Health and Safety Act 2004* requires employers to maintain a written record and notify WorkSafe Victoria of incidents and dangerous occurrences in the workplace. Also, Section 22(2)a of the *Occupational Health and Safety Act 2004* requires employers to 'keep information and records relating to the health and safety of employees of the employer'. Some employers have included the reporting of pain and symptoms, as well as small incidents not resulting in injury in their injury and accident reporting procedure. Your workplace should have such a system and should use the data to identify possible hazards and areas of concern.

Check injury records, first aid reports and workers compensation claim forms for information about the work tasks, the area in which work is performed, the activity being undertaken at the time of injury, factors thought to be related to the incident and the type of symptoms or injury reported.

Check particularly for reports of pain in the back, neck, shoulders and upper limbs; cuts or bruising; trip and fall incidents; and headache and vision problems. The absence of any history of accidents or incidents, or a small number of such incidents should not be taken to mean that the hazard does not exist.

### Use of Codes of Practice

The *Occupational Health and Safety Act 2004* no longer provides for the creation of codes of practice. However, Codes of Practice written under the 1985 legislation can be used as guidance material. Regulations and Compliance Codes give specific guidance on compliance with the 2004 Act. The Victorian *Code of Practice for Manual Handling 2000* and the *National Code of Practice for the Prevention of Occupational Overuse Syndrome (1994)* provide guidance for identifying some hazards in an office environment and could be used as a starting point.

### Conduct a walk-through inspection of the office using a hazard checklist

A checklist is a useful method for identifying hazards. You do not have to be an expert in health and safety to use one. A good checklist provides a systematic method to ensure that you do not miss hazards. It enables you to gather important information and record it quickly so that it can be considered more thoroughly during the assessment. An example of a checklist is included in Appendix C. The National Occupational Health and Safety Commission (NOHSC) *Guidance Note for the Prevention of Occupational Overuse Syndrome in Keyboard Employment (1996)* also contains a checklist that can assist in the identification of some office-based hazards.



# MANAGING OCCUPATIONAL HEALTH AND SAFETY IN THE OFFICE



Figure 1.3 Reducing risk by using a telephone headset

## What to consider when assessing risk

### *The likelihood of the exposure leading to injury or disease*

Data from WorkSafe Victoria, Comcare Australia, Office of the Australian Safety and Compensation Council, journals and texts will indicate the likelihood of injury or illness arising from different types of health and safety hazards in the workplace.

Typically the common injuries include:

- musculoskeletal disorders of the back, neck and upper limbs;
- minor injuries due to cuts, trips or falls or being hit by an object; and
- stress-related conditions.

The employer should assess the likelihood of these or other injuries at their workplace.

### *The frequency and duration of exposure*

How often and for how long employees may be exposed to a particular hazard should be estimated or measured by consulting with employees, looking at duty rosters and observing employees performing the work.

### *Who may be affected*

Determining tasks and areas that may be affected by a particular hazard can help direct limited resources to those areas where the most effect can be obtained from control measures.

## What to consider when controlling risk

A range of measures for controlling risk involves elimination, substitution, isolation, engineering, administration and personal protective equipment.

### *Elimination*

Redesigning the job to design out risks altogether is the most effective method of risk control. For example, the need for excessive photocopying and collation can be eliminated if memoranda are circulated by email. A quality photocopier can sort, collate and staple to eliminate manual handling.

### *Substitution*

Materials, equipment or processes can be replaced with less hazardous ones. For example, a telephone handset can be replaced with a headset where there is prolonged use of the telephone or where typing is required while using the telephone.

### *Isolation*

Enclosing or isolating the hazard from employees can eliminate or reduce the risk of injury or illness. For example, a photocopier can be located in a separate well ventilated room to isolate noise and fumes.

### *Engineering*

Engineering controls may involve the provision of mechanical aids, barriers, guarding, ventilation or insulation to prevent employees being exposed to a hazard. For example, a heavy compactus system may have a mechanical winder or electric controls to prevent the need for pushing and pulling the sections.

### *Administration*

This may involve establishing policies, procedures and work practices designed to reduce an employee's exposure to a risk. It may also relate to the provision of specific training and supervisory practices. For example, by advising employees against performing continuous keyboard work for long periods, and increasing task variety.

# MANAGING OCCUPATIONAL HEALTH AND SAFETY IN THE OFFICE

---

## ***Personal protective equipment***

This may involve using appropriate protective clothing, such as gloves when handling cleaning solvents, as a method of reducing an employee's exposure to risk.

Risk control measures should be applied as appropriate in the order listed above. A combination of substitution, isolation and engineering controls may be applied simultaneously. For example, training employees in lifting techniques may not sufficiently reduce manual handling risk of relocating office furniture. Higher level control options, such as providing mechanical aids or eliminating the job altogether by contracting it out to a specialist furniture removalist will be more effective.

## **Evaluation of control measures**

Evaluation of risk control measures determines their effectiveness. For example, introducing exercises or rest breaks for repetitive keying tasks does not completely control all risks involved in the task. The evaluation of control measures may involve the reworking of the process of hazard identification, risk assessment, risk control and evaluation of control measures. Satisfactory control of risk is often a gradual consultative process, involving trialling and refining risk control measures in the light of employee feedback, new technology and changes in scientific knowledge over time.

## **Safety management systems**

To manage health and safety, every organisation, large or small, needs to evaluate the degree of risk associated with its operations. The higher the risks, the more extensive the management systems needed to maintain a safe workplace. By identifying the strengths and weaknesses of current systems, an organisation is better able to identify and plan improvements to its health and safety management performance. The level of documentation and the complexity of systems required are determined by the exposure of people to health and safety risks, not the size of the organisation. An example of such a system is WorkSafe Victoria's SafetyMAP.

### **SafetyMAP (Safety Management Achievement Program)**

SafetyMAP is an audit tool developed by WorkSafe Victoria to assist organisations evaluate the effectiveness of their health and safety management systems. Underpinning SafetyMAP are the general principles of risk management – hazard identification, risk assessment and risk control. The flexibility of SafetyMAP has enabled it to be successfully used in organisations of all types and sizes, and in all types of industries.

There are two levels of achievement within SafetyMAP – initial and advanced – so organisations can plan their own rate of progress and set their own goals. The elements within SafetyMAP encourage the use of a continuous improvement cycle and the involvement of all the workplace stakeholders in health and safety.

Where new systems are introduced or the organisation identifies a problem, changes are made and progress is reviewed. This evaluation and review process should be part of a plan for improving health and safety that includes realistic, achievable goals and time frames. The audit criteria are also used to verify that existing systems are working, and to identify any failures, determine priorities and allocate resources in the way that best suits the organisation's needs.

Success begins with the commitment of senior management to provide the focus and support for the safety program. Management must also plan the changes and secure the resources needed to implement improvements. Continued progress requires the effort and involvement of all levels of the organisation. Achievements can be recognised by an independent systems audit. A list of JAS-ANZ accredited Certification Bodies that can provide this service can be obtained from JAS-ANZ or WorkSafe Victoria.

# MANAGING OCCUPATIONAL HEALTH AND SAFETY IN THE OFFICE



## OCCUPATIONAL HEALTH AND SAFETY LEGISLATION

### What does the legislation consist of?

Occupational health and safety legislation has two major parts. These are:

- Acts (in Victoria, the parent Act is the *Occupational Health and Safety Act 2004*); and
- Regulations or Compliance Codes made under the Act.

Occupational health and safety legislation provides a framework for health and safety management in all workplaces and allows for flexibility in the choice of risk controls.

### **The Occupational Health and Safety Act 2004**

The Act clearly spells out duties for all workplace parties, including:

- employers;
- employees;
- self-employed persons;
- persons who manage or control workplaces;
- designers of buildings and structures;
- designers, manufacturers and suppliers of plant and substances; and
- installers of plant used in the workplace.

It provides a framework that must be followed for employers and employees to work together to make decisions about health and safety.

### **Regulations**

Regulations set out legal requirements for the management of various health and safety hazards and issues. Where they exist, they must be used in a workplace.

Most Regulations written under the previous *Occupational Health and Safety Act 1985* will continue for 2 years after the introduction of the 2004 Act or until revoked. The Occupational Health and Safety (Incident Notification) Regulations 1997 have been repealed and have now been incorporated into the 2004 Act with some minor changes.

### **Compliance Codes**

Compliance Codes provide practical guidance about what constitutes compliance with the occupational health and safety (OHS) laws to people who have duties or obligations under the *Occupational Health and Safety Act* or the Regulations. A person who complies with a Compliance Code is taken as complying with the Act.

### **Codes of Practice**

Codes of Practice made under the 1985 Act give practical guidance to people who have duties or obligations under Victoria's OHS laws. WorkSafe will continue to regard those who comply with the topics covered in the Codes of Practice as complying with OHS laws. Codes of Practice will be progressively reviewed and replaced with guidance material and, in appropriate cases, with Compliance Codes.

### **Technical reports, guides and guidance notes**

Technical reports and guidance notes provide specific information on aspects of health and safety. While not legal requirements, they provide advice to assist decisions regarding health and safety where Regulations and Compliance Codes do not exist.

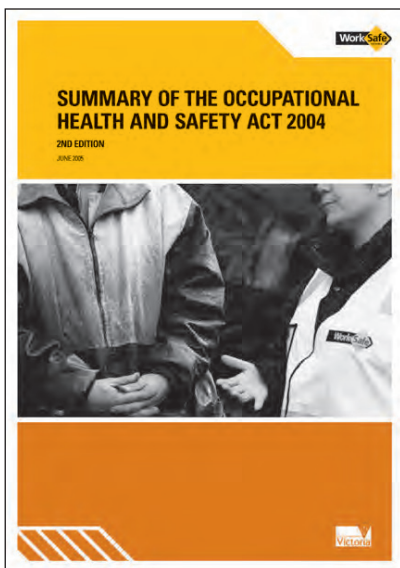
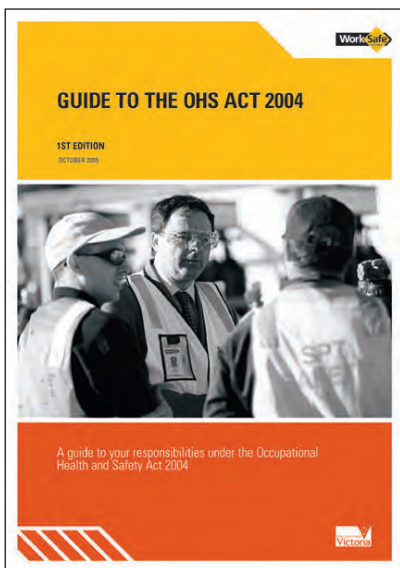

# MANAGING OCCUPATIONAL HEALTH AND SAFETY IN THE OFFICE

---

## ***Australian Standards***

There are many Australian Standards that relate to work in offices. Standards set some basic requirements in the design, development and use of equipment, furniture, plant and work practices in both office and industrial work environments. Australian Standards are not law unless incorporated into Regulations. However, where an issue in law is being considered, reference can be made to Australian Standards if there are no Regulations or Compliance Codes for making decisions. Specific Australian Standards are sometimes referenced in Compliance Codes. Where relevant, Regulations, Compliance Codes, technical reports, guidance notes and Australian Standards are referenced in this guide. These publications should be used to help organisations in the effective management of health and safety issues in the office.

The Office of the Australian Safety and Compensation Council (ASCC) provides national standards and codes of practice which can be called up under legislation to be used as compliance tools. A new standard and code of practice on manual handling from NOHSC (now the ASCC) will be published in 2006 to give guidance on manual handling and replace the previous *National Code of Practice for the Prevention of Occupational Overuse Syndrome (1994)*.

## **DEVELOPING A HEALTH AND SAFETY POLICY**

Preparing a health and safety policy is an important practical step towards providing and maintaining a work environment which is safe and without risk to health. A successful policy is developed in consultation with senior management, Health and Safety Representatives and employees.

### **What should a health and safety policy do?**

The policy statement should indicate, in clear and simple terms, the company's health and safety policy objectives and the arrangements to achieve those objectives, including the allocation of functions and responsibilities. It should be signed and dated by the director, or equivalent, of the organisation. Issues which should be covered include:

- senior management commitment;
- the integration of that commitment into all organisational activities;
- a commitment to set down the functions and duties of all people in the organisation for maintaining workplace health and safety;
- accountability of all levels of management;
- consultation leading to effective action;
- training in and communication of health and safety practices and procedures;
- and
- regular monitoring and reviewing of the policy and its effectiveness.

### **Specific health and safety policies**

Health and safety policies about specific issues such as smoking, drugs, alcohol and transmissible diseases should be consistent with an organisation's general health and safety policy. Specific policies and procedures will be more successful where there is an existing general health and safety structure. These policies will vary from one organisation to another, as they reflect the particular needs and operational requirements of individual organisations. However, all specific health and safety policies must fulfil the requirements of relevant legislation.

Health and safety procedures should be developed by management in consultation with employees and their Health and Safety Representatives. The procedures should detail the organisational arrangements for identifying, assessing and controlling hazards or dealing with specific health and safety issues. They should lay the basis for management and supervisor responsibilities, employee involvement, setting of goals and action plans, and review of the effectiveness of the implementation.

# MANAGING OCCUPATIONAL HEALTH AND SAFETY IN THE OFFICE

## Implementing health and safety policies

For a specific health and safety policy to be effective, a plan should be developed. The implementation of the plan should involve consultation and cooperation between management and employees to effectively translate the policy objectives into effective action. Regular monitoring and reviewing of the plan ensures that it remains in line with changes in legislation and organisational needs.

A copy of the policy document should be displayed in a prominent place for employees to view. Many organisations integrate health and safety policies into their quality management systems.

Refer to Section 6 for a discussion of specific health and safety policies in the office.

### CHECKLIST – MANAGING OCCUPATIONAL HEALTH AND SAFETY

- Do you have an OHS policy, including commitment of the organisation, general issues and, where necessary, specific issues?
- Are there documented OHS procedures?
- Is there a systematic approach to managing OHS risks (hazard identification, risk assessment, risk control and evaluation)?
- Is there a consultative process in place (committee, employee representation, communication) to manage OHS?
- Are injuries and incidents reported and the risks assessed?
- Is there training in OHS for employee and employer representatives?
- Do you know where to go to access occupational health and safety resources, e.g. WorkSafe Victoria, Australian Standards, ASCC/NOHSC documents?

# 2

## JOB DESIGN IN OFFICE WORK

This section describes the physical and psychosocial factors that need to be considered in matching jobs to people's capacities. It discusses common physical injuries that occur in office work – including musculoskeletal disorders (MSD). It describes both the physical factors and the psychological and social stressors that need to be considered.

Examples are provided of how this information can be used to design work to better meet the needs of people working in offices.

### PHYSICAL FACTORS

People come in all shapes and sizes and have a wide range of different needs, capacities and limitations. Good job and work environment design relies on matching the work and environment to people's needs, capacities and limitations. Some of the consequences of a mismatch in this area are discussed in this section.

#### Manual handling in the office

Manual handling refers to any activity requiring the use of force exerted by a person to lift, push, pull, carry or otherwise move or restrain something. Examples of manual handling tasks commonly performed in offices include lifting and carrying boxes of photocopying paper; moving office furniture and equipment such as computers and printers; handling large files, books and legal documents; prolonged data entry; and opening and closing filing cabinet drawers.

#### Musculoskeletal disorders

MSD is a collective term for a range of conditions characterised by discomfort or pain in muscles, tendons and other soft tissues, with or without visible symptoms. MSD are usually associated with tasks involving repetitive movement, sustained or unnatural postures or forceful movements. Previously these conditions have been referred to in various ways, such as Occupational Overuse Syndrome (OOS) or Repetitive Strain Injuries (RSI).

Muscle strains can occur suddenly, and may result from forceful exertion in a bent or twisted posture – for example, lifting a box of photocopying paper from the floor. However, many MSD occur due to daily work involving the maintenance of static postures, which result in muscle fatigue, for example, holding the telephone, and repetitive work such as keyboard and mouse tasks. Conditions that have this type of gradual onset are probably more common in office work than sudden injuries. Ways of reducing manual handling and the risk of MSD are suggested in various sections of this guide.

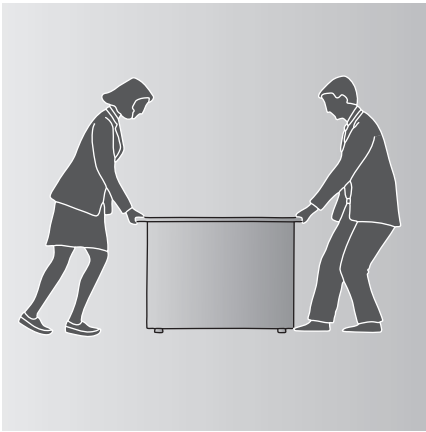

Figure 2.1 Moving office furniture

In office work, other factors that have been associated with MSD include prolonged and intense keyboard or mouse use, high demands on vision, sustained mental effort and peak demands or set work rates. Control of these factors is discussed in a number of sections of this guide.

The best way to prevent the development of any injury due to manual handling is to design jobs, tasks and the work environment (including equipment and furniture) so that the factors that contribute to the risk of injury can be avoided or minimised. To achieve this, all the factors that can increase risk must be identified and managed.

In Victoria the *Occupational Health and Safety (Manual Handling) Regulations 1999* set out the legal requirements for workplace parties in managing manual handling risk. The *Code of Practice for Manual Handling 2000* provides some practical guidance for managing manual handling risk in office tasks that may pose risk of MSD.

## PSYCHOSOCIAL FACTORS AT WORK

Work is generally beneficial to mental health and personal wellbeing. It provides people with structure and purpose and a sense of identity. It also provides opportunities for people to develop and use their skills, to form social relationships, and to increase their feelings of self-worth.

There are circumstances, however, in which work can have adverse consequences for health and wellbeing. Risks to psychological health at work may arise from organisational or personal factors, with the major factors being poor design of work and jobs, poor communication and interpersonal relationships, bullying, occupational violence and fatigue.

Risks to psychological health due to work should be viewed in the same way as other health and safety risks, and a commitment to prevention of work-related stress should be included in an organisation's health and safety policies. Employers' duties under the *Occupational Health and Safety Act 2004* include the prevention of risks to psychological health by identifying work-related stress factors, assessing the risks to employees and controlling the risks as far as is reasonably practicable.



Figure 2.2 Worker overload can cause stress

### Stress

Stress is a word used loosely in the community and is a complex emotional experience. Positive challenges motivate people psychologically and physically to learn new skills and master their jobs. This 'good' stress can lead to high levels of satisfaction and productivity. However, challenges can also be personally distressing and disruptive. Work that results in a person feeling unable to cope and unsupported may lead to an adverse psychological reaction known as stress and may lead to illness, injury and job failure. However, stress is not just feeling sad, upset or angry. It is interactive and people can have very different responses to the same factors. We do know that some workplace factors may contribute to stress reactions.

These may arise from the content of work, for example:

- work which is monotonous or lacks variety, or too much or too little work to do;
- work that involves employees having to hide their feelings when dealing with customers, or performing work that goes against personal or social standards;
- unpredictable, long or unsocial working hours, poorly designed shift systems;
- employees being unable to participate in decisions about their work or control how they do it; and
- environmental conditions such as poor lighting, excessive noise, heat and complex or inadequate equipment or technology.

# JOB DESIGN IN OFFICE WORK

Stress can also arise from the social and organisational context to work, for example:

- inadequate communication systems with supervisors or co-workers;
- uncertainty, e.g. no clear instructions on what employees are expected to do;
- job change, e.g. in task content, hours, location, supervision, without adequate consultation;
- recruitment policies which fail to ensure employees have suitable skills for the work and do not adequately train staff;
- under/over promotion or job insecurity;
- work involving reward systems (pay, recognition or promotion) leading to employees working long hours, taking work home or pushing themselves to a point where their health and safety is at risk;
- poor relationships between supervisors, peers or others at work, not acknowledged and rectified;
- emotionally or physically demanding jobs with inadequate support;
- inconsistent people management or not in line with workplace policies, e.g. discrimination related to performance appraisal; and
- conflicting demands of home, family and work.

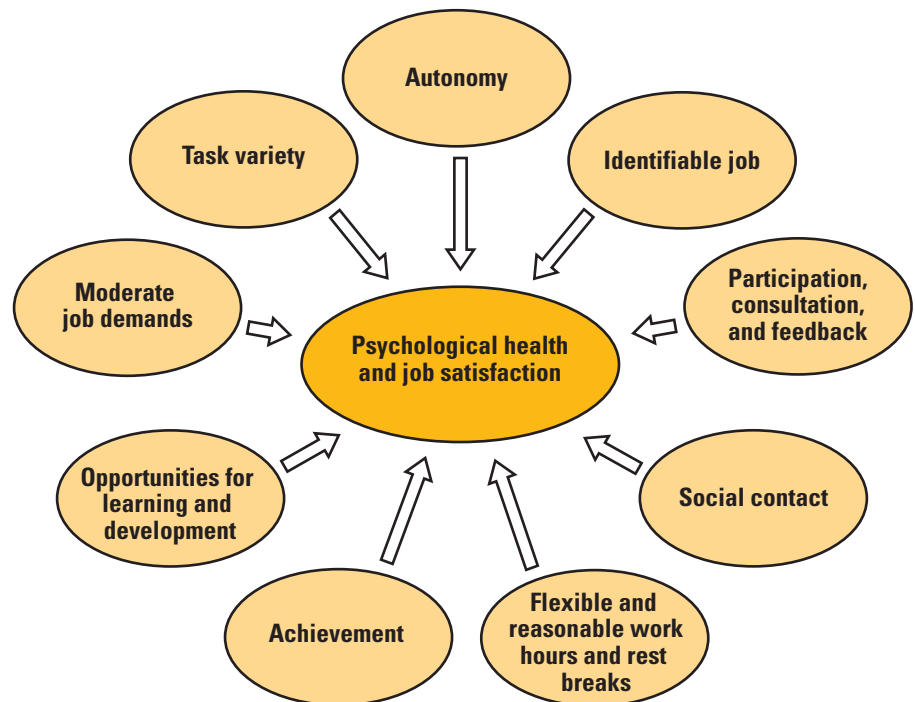

Risks to psychological health may be identified from various sources in the workplace, such as records of claims and high levels of absenteeism or sick leave, self report information such as interviews and surveys and through consultation with Health and Safety Representatives and employees on current issues and risks.

To assess these risks, employers should consult with work groups to determine the key work-related or other stress factors, the circumstances, the exposure (frequency and duration), the harm they cause and how employees think they could be managed.



## Bullying

Workplace bullying is repeated unreasonable behaviour directed towards a worker or group of workers that places their health or safety at risk and is likely to victimise, humiliate, undermine or threaten them.

Bullying usually comes from a source inside the workplace and the bullying may be employee to employee; employer to an employee or group of employees; a group to an individual or another group; or clients and customers to employees.

The following types of behaviour, if repeated, could be considered bullying:

- verbal abuse, excluding or isolating particular workers, harassment or intimidation;
- assigning meaningless tasks unrelated to the worker's job or tasks that are impossible for the worker to successfully complete;
- changing work rosters with the deliberate intention of inconveniencing particular workers;
- intentionally withholding information that prevents a worker from effectively carrying out the job; and
- unreasonable threats of dismissal.

Particular employees can be vulnerable to bullying including new employees, trainees, contractors or casual workers, minority ethnic groups or particular age groups or genders. Bullying is more likely to occur in workplaces which tolerate teasing and practical jokes; where people who manage staff lack experience and skill in dealing with employee groups; and where there are long hours and a high intensity of work.

While a single incident does not constitute bullying, isolated incidents that are perceived or reported as bullying should not be ignored. All such incidents should be investigated and addressed to ensure that repetition is prevented.

Physical assault (or the threat of physical assault) should be regarded as occupational violence and dealt with accordingly. The WorkSafe guidance note *Prevention of Bullying and Violence at Work* provides more detail. The guidance note recommends an integrated approach to prevention, starting with creating awareness, developing a policy, informing and training, identifying risk factors, controlling risks and encouraging reporting.

## Occupational violence

Occupational violence refers to any incident in which a worker is physically attacked or threatened in the workplace, including any statement or behaviour that causes them to believe they are in danger of being physically attacked. The term 'occupational violence' applies to all forms of physical attack on workers, including:

- striking, kicking, scratching, biting, spitting or any type of direct physical contact, pushing, shoving, tripping, or grabbing;
- throwing objects;
- attacking with any type of weapon; and
- any form of indecent physical contact.

Violence in office workplaces can be perpetrated by co-workers (including managers, supervisors or employers), customers (e.g. in a reception area), people known to the organisation or employee, or a stranger such as an intruder. In some circumstances, violence can be a crime and incidents should be reported to the police.

The nature and location of work, the types of clients, hours of operation and staffing levels can all affect the risk of occupational violence instances. Some common risky situations include:

- denying someone a service or dealing with frustrated customers;
- working alone or at night;
- handling cash; and
- working in human services where clients are potentially violent.

Part 2 of the WorkSafe guidance *Preventing Occupational Violence* provides a more detailed list of risk factors to consider.

# JOB DESIGN IN OFFICE WORK

---

## **Fatigue**

Fatigue is an acute or chronic state of tiredness which affects employee performance, safety and health and requires rest or sleep for recovery. Fatigue may affect physical and mental capacities and increase the risk of workplace incidents. It can also contribute to workplace conflict and absenteeism. Through a build-up of sleep debt, fatigue can result in errors of judgement that may lead to injury or death, affecting not only the employee, but the health and safety of others as well.

The fatigue factors that influence risk include:

- mentally and physically demanding work (very high demands);
- long periods of time awake (e.g. long hours of work extended by long commuting times);
- inadequate amount or quality of sleep (e.g. when 'on-call');
- inadequate rest breaks (e.g. inadequate or poorly timed rest breaks or rest breaks where the environment is not conducive to rest);
- disruption of the body clock (e.g. working when we would normally be sleeping);
- environmental stresses (e.g. noisy or hot environments); and
- work requirements, work schedules or systems of reward (pay, recognition or promotion) that provide incentives to work longer and harder than may be safe.

## **Shift work**

Research shows there are significant issues associated with fatigue from shift work. Shift work is not so common in office work, however, workplaces which respond to the public may have shifts over a 24 hour period, for example, a call centre.

Many aspects of human performance are at their lowest levels during the night, particularly between 2:00am and 6:00am. Disruption to the body clock by working during these hours can affect behaviour, alertness, reaction time and mental capacity.

Prolonged night shifts can result in sleep debt, as sleep cycles are usually about two hours shorter when sleeping during the day after working a night shift. Day sleep and sleep during 'on-call' periods at night are usually of a lesser quality than night sleep.

Individuals adjust to shift work in different ways, so it is essential to consult your workers when putting together staffing arrangements and work schedules.

Prolonged fatigue can have detrimental effects on physical and mental health, for example, sleep disorders, mood disturbances, gastrointestinal complaints, headaches, depression, cardiovascular disease and irregular menstrual cycles.

Fatigued individuals in the workplace may complain of feeling drowsy or of headaches, and may show symptoms such as increased irritability, blurred vision, falling asleep at work, making mistakes or having near-misses, yawning, moving off track while driving vehicles or increased absenteeism.

Personal factors can contribute to work-related fatigue, for example, employees with multiple jobs or lack of sleep due to young babies. Not all the factors noted mean there is a risk of fatigue in the workplace, but where the work involves potential for fatigue, the employer must assess the risk to determine whether risk control measures are required.

## REDUCING STRESS THROUGH GOOD JOB DESIGN

Eliminating or reducing risks to psychological health has advantages for the health and wellbeing of employees. Where employees have open communication and consultation and feel supported and engaged in their work, there is likely to be improved productivity, less absenteeism and unrest, and staff will be retained. There are various strategies to reduce risk to psychological health from work stress. Some strategies that focus on the sources of risk are listed below.

### Content of work factors

- Designing jobs so the demands of the work meet the capabilities of workers by: modifying the way the job is done or the working environment; sharing the workload differently; setting reasonable deadlines and quality standards; ensuring there are sufficient resources and time to do the work; providing variety in work.
- Ensuring safe work schedules by: providing suitable rest breaks; sufficient time for recovery from fatigue and enough notice for people to prepare when hours of work are changed; designing shifts, long hours or work at night to minimise fatigue at work and when commuting.
- Improving workplace consultation and employee participation in decision-making by: introducing flexi-time, job sharing or other ways to meet people's needs while ensuring productivity is maintained or improved; providing employees with some control over how they do their work; consulting with employees and Health and Safety Representatives in decisions that affect their work.
- Improving equipment, technology, facilities and physical working conditions by: providing suitable, effective and reliable equipment and technology; providing control over lighting, noise and the thermal environment.

### Social and organisational work factors

- Providing effective systems for managing customer-related issues by: introducing or improving policies, procedures, training and social support and effective communication systems that enable employees to deal effectively with customers (including managing threatening or inappropriate behaviours).
- Ensuring there are effective opportunities for communication, consultation and feedback between supervisors and staff or co-workers.
- Developing a supportive workplace culture by: ensuring suitable leadership which delegates, encourages participation and initiative, enhances co-operation and teamwork, and makes clear the organisation's objectives.
- Establishing clear roles by: ensuring roles and responsibilities are clearly specified; regularly reviewing and where required modifying roles in consultation with staff; reviewing relevant roles and responsibilities when role conflicts emerge.
- Ensuring that employees have or develop appropriate knowledge and abilities to perform their jobs effectively by: effective recruiting of people with the right mix of skills for work and providing training; providing opportunities for career development; regular and effective progress reviews.
- Developing suitable systems to manage and develop work performance by: implementing an effective workplace performance management system with clear expectations and procedures that are understood by managers and employees; providing positive feedback on performance; identifying and planning areas for improvement, future goals and training needs; recognising and rewarding achievements.
- Establishing suitable work/life balance policies by: providing flexible working time arrangements, e.g. part-time or home-based work, job sharing, phased retirement, additional purchased leave or non-standard working hours.
- Implementing policies and procedures to manage workplace issues such as workplace bullying, occupational violence and conflict by using agreed workplace consultative procedures and, where required, bringing in mediation.
- Managing serious incidents, workplace grievances and disputes and resolving occupational health and safety issues by putting in place effective consultative structures such as a committee and Health and Safety Representatives.

# JOB DESIGN IN OFFICE WORK

---

- Consulting with workers when determining the best way to deal with identified problems. This will ensure measures to control or reduce risk are practical, more likely to be effective and are 'owned' by the workgroup.
- Providing training and information about risks to psychological health from stress by raising awareness, and disseminating information about workplace prevention actions.
- Establishing a process for reporting and responding to reports of stress, including mechanisms for early identification, reporting and management of stress-related issues, and training managers and staff in these processes.
- Giving employees access to an Employee Assistance Program (EAP). EAP personnel are usually qualified counsellors/psychologists and work for an external, independent organisation. They can assist employees by providing confidential support and counselling for either work-related problems or personal issues which affect work.

Comcare's *Working Well: an organisational approach to preventing psychological injury (2005)* has advice for organisations on managing stress factors in the workplace.

## **Bullying at work**

Although bullying may appear to be different to work-related issues, it can be managed within the same risk reduction framework by:

- developing and communicating a 'no bullying' policy and procedures for reporting, investigating and resolving incidents;
- raising awareness to help employees recognise the circumstances in which workplace bullying may be more likely to occur;
- providing appropriate training, particularly for those with supervisory roles; and
- protecting at risk groups by introducing a 'buddy' system for new workers; and
- additional training, for example, in workplace diversity and specific training for supervisors and managers.

## **Occupational violence**

Eliminating the reason for violence should be the first step to preventing violence. Examples include:

- removing the incentive for occupational violence by not having money, drugs or valuables on the premises; and
- changing customer contact arrangements, e.g. by providing services over the phone instead of in person or withdrawing service to a customer who is known to be violent.

If it is not possible to eliminate the risk then the next steps are to reduce the risks as much as possible by:

- changing the equipment or process, e.g. replacing breakable glass panes with safety glass or removing items that could be thrown; and
- designing for safety, e.g. increasing the depth of the reception counter to create more space between the customer and the staff member.

Use Crime Prevention Through Environmental Design (CPTED) principles to:

- ensure there are clear sightlines between public areas and individual or separate work spaces, as well as effective lighting and landscaping that does not provide hiding places;
- control access for internal or high-risk areas, and ensure landscapes are designed so that pedestrians are directed through appropriate routes;
- create a clear distinction between public and non public spaces and display appropriate signs; and
- use good design and maintenance of public spaces to encourage a sense of ownership and responsibility.

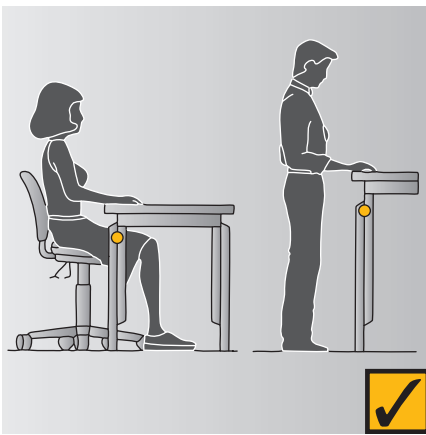

Figure 2.3 Relaxed, comfortable work positions

Other methods to reduce the risk include:

- providing training to help workers identify potentially volatile situations and know how to de-escalate potential violence in management of customer service and complaints, and emergency response procedures (including violence, fire, bomb scare, armed hold-up);
- providing written and/or verbal hand-over on the status of risk (e.g. customers who have exhibited potential for violent behaviour during a previous shift);
- providing secure cash management and entry and exit from the premises (particularly at night);
- providing duress alarms, personal alarms or mobile phones where customers may be violent or staff work alone;
- developing a plan for violent incidents, including provision of first aid, comfort to those affected, communication to emergency services, maintaining an undisturbed scene, asking witnesses to remain and contacting families;
- reporting on the threats or incidents and assess possible triggers for the threats; and
- providing post-incident reporting, debriefing and review.

## Managing fatigue and shift work

Where reasonably practicable, shift design should try to eliminate early morning start times (before 6:00am), late finish times, work between 2:00am and 6:00am, long hours of work and the need to work overtime or extended shifts. If risks cannot be eliminated:

- improve shift schedules or rosters to prevent build-up of sleep debt (cumulative fatigue when normal sleep or rest is disrupted over time);
- provide back-up for absences rather than having others work longer hours to cover absences;
- change work requirements, work schedules or systems of reward (pay, recognition or promotion) that provide incentives to work longer and harder than may be safe;
- provide adequate rest breaks and an environment conducive to rest;
- provide training and information about risks to health and safety from fatigue, e.g. raise awareness, and disseminate information about the strategies that the workplace is using to prevent fatigue risk;
- provide information for shift workers on managing fatigue, e.g. planning optimum sleep conditions, developing sleep and wake time routines, maintaining exercise and regular healthy eating patterns and minimising caffeine, alcohol or high-fat food intake prior to sleep; and
- provide safe travel arrangements for employees following long hours of work or when commuting during normal sleeping hours.

## Improving physical job design

The important aspect of physical job design is that it fits with how our bodies operate. Points to consider include:

- joints should be in relaxed and comfortable positions (see Figure 2.3). This makes the work of muscles, ligaments and tendons around joints more efficient. Where extreme positions must be used, they should be held for as little time as possible and not repeated often;
- the work should be kept as close as possible to the body to minimise the stress on the body when reaching to perform a task;
- commonly accessed items should be stored between hip and shoulder height where possible to avoid bending over and reaching up;
- repetitive tasks such as using a keyboard and mouse should be performed for short periods. They are best interspersed with other tasks requiring different postures and movements, e.g. collecting work at the printer, reviewing, photocopying and distributing documents;
- static or fixed postures should only be held for short periods of time and interspersed with different tasks;

# JOB DESIGN IN OFFICE WORK

---

- job design should provide the opportunity for people to sit, stand or walk a short distance as a normal part of their duties;
- exertion from the use of excessive force should be avoided; and
- exertion of force should be done in an upright posture, without twisting the spine and preferably using both hands equally.

## ***Keyboard skills***

Where the user does not have good typing skills, the risk of sustaining a muscle strain can increase as the operator may frequently or for a sustained period bend their neck to see the keyboard or the document they are typing from. When beginning to use computers, it is important to learn basic typing skills. This can be achieved through short but frequent training with the use of tutorial software programs. This approach can equally apply to two finger typists who may have developed a reasonable knowledge of the keyboard but cannot operate it without looking at the keys. This method of work is habitual and a concerted effort is needed to help with the development of new work methods.

## ***Task variety***

It is important to include task variety in the design of work. This is best done by mixing intensive keyboard use and other computer use with a variety of other work. It is important that the different tasks involve a change in posture and muscles used to perform the work.

As the working day progresses it becomes more important to provide work with different mental demands, changes in posture and more frequent work breaks.

## ***Breaks***

Rest or work breaks can range from short pauses to defined breaks such as lunch. Answering the phone or collecting a document from the printer are short breaks that provide an opportunity for muscles that have been active in keyboard or mouse use to rest and recover and muscles which have been fixed during this use to move.

Where a variety of alternative tasks are not available, it is important to have more work breaks away from the task. The length of these and how often they are taken depends on the work, the person and other factors. Frequent short pauses are preferable to infrequent longer pauses.

The use of exercises during breaks can provide a variety of changes in posture and movement for muscles during periods of intense work (see Appendix D). These exercises may be useful where there are no alternative tasks available. Exercises should not be used to replace other controls listed above. Exercises should be gentle stretches which provide rest for frequently used muscles and movement for muscles which have been static. The best exercise is usually to get up from a seated position and move around.

## ***Work adjustment periods***

It is important that during employee absences, their work is not left to pile up awaiting their return. This situation can cause an overload that can increase the risk of MSD and loss of job satisfaction.

Where employees are new to keyboard use and other office-based tasks or are returning from an absence of several weeks, a period of adjustment may be required. The adjustment period will depend on the individual, the equipment, the environment and the duration of computer-based work involved. Where there is highly repetitive work, such as keyboard and mouse use, adjustment may be achieved through reduced work loads or provision of a greater variety of tasks than usual with a gradual reintroduction of highly repetitive or demanding work.

## CHECKLIST – JOB DESIGN IN OFFICE WORK

### Have hazardous manual handling tasks been assessed and controlled as far as is practicable, including:

- Repetitive or sustained force, awkward posture or movement?
- Application of high force?
- Handling of people, animals or loads which are unstable, unbalanced or difficult to grasp or hold?

### Have social and psychological stressors been assessed and controlled as far as practicable, including:

- Job content issues (such as overload, lack of control or variety, high levels of repetition or concentration, poor physical environment)?
- Social and organisational issues (such as conflicting demands, inconsistent expectations, personal relationships, inadequate training)?
- Bullying (such as intentionally withholding information, excluding or isolating workers, unreasonable threats of dismissal, harassment)?
- Occupational violence (such as physical assault or threat, indecent physical contact, pushing, shoving)?
- Fatigue (long hours, inadequate breaks, demanding shift patterns)?
- Physical demands of jobs (excessive repetition, awkward and static postures, unrealistic deadlines)?

# 3

## DESIGNING A HEALTHY AND SAFE WORKING ENVIRONMENT

This section discusses health and safety issues relating to environmental factors in offices, including lighting, noise and air quality.

### LIGHTING IN THE OFFICE

Good lighting in workplaces is essential to enable people to see clearly and perform their work safely.

The key factors to consider when determining the adequacy of lighting are the:

- amount of light in an area;
- number, type and position of the light sources; and
- tasks or activities performed, how often and for how long these are performed.

In general, good lighting should enable people to easily view their work and environment without the need to strain their eyes. However, different activities require different levels and qualities of light. The visual demands of the activity or task performed determine the lighting needs of an area. Activities that do not require a high level of visual acuity – for example, walking through a corridor – do not require high levels or an optimum quality of light. On the other hand, tasks such as drawing or checking a document for errors involve fine and detailed work requiring a moderate to high level of visual control, and so greater levels and a higher quality of light are required.

#### How much light is needed?

We are able to see quite well in a wide range of lighting levels due to the ability of the eye to adapt to different lighting conditions. For example, when you move from a bright room into a relatively dark area, or vice versa, your eyes adapt and over time (some seconds) you are able to see more clearly. To reduce the demands on your eyes and the need to adapt when changing tasks or viewing fields, or when moving from one work area to another, specific levels of lighting for particular types of tasks are recommended (see Figure 3.1).

#### How is light measured?

The amount of light in an area can be measured using a light meter (or lux meter). This measures the amount of light falling onto a surface, which is known as the illuminance of that surface. Illuminance is measured in lux. Recommended illuminance levels for different types of work areas are approximate and are shown in the accompanying table.



# DESIGNING A HEALTHY AND SAFE WORKING ENVIRONMENT

CLASS OF TASK	RECOMMENDED MAINTENANCE ILLUMINANCE (LUX)	CHARACTERISTICS OF THE ACTIVITY AND INTERIOR	REPRESENTATIVE ACTIVITIES & INTERIORS
<b>Intermittent use</b>	80	Interiors requiring intermittent use with visual tasks limited to movement and orientation	Staff change rooms
<b>Simple</b>	160	Occasional reading of clearly printed documents for short periods	Waiting rooms
<b>Ordinary or moderately easy</b>	240	Continuously occupied interiors where moderately easy visual tasks with high contrasts or large detail are required	Computer usage
<b>Moderately difficult</b>	400	Areas where visual tasks are moderately difficult with low contrasts	Routine office work
<b>Difficult</b>	600	Areas where visual tasks are difficult with low contrasts	Drawing offices (boards), proof reading

Figure 3.1 Recommended illuminance levels for various types of office tasks, activities and interiors. Adapted from AS 1680 – Interior Lighting

## Quality of light

This refers not only to the level of lighting, but also to other factors which have a significant impact on how well we are able to perform a task. These include:

- the number of lights in use – having the correct number of lights will provide evenness of lighting over the area;
- the type of lights, e.g. fluorescent tubes, tungsten and halogen lights – the most common type of office lighting is fluorescent, most resembling natural light and long-lasting. Fluorescent lights can provide different qualities of light, such as white, warm, natural, daylight or colours;
- the type of light fittings used – the design of light fittings can influence the direction of lighting;
- the position of the lights – lights should be positioned to illuminate the workstations;
- how colours appear under them; and
- maintenance of the lighting system.

All these factors need to be taken into account when designing lighting for office environments. A lighting designer should be consulted for designing lighting in a new office area.

# DESIGNING A HEALTHY AND SAFE WORKING ENVIRONMENT

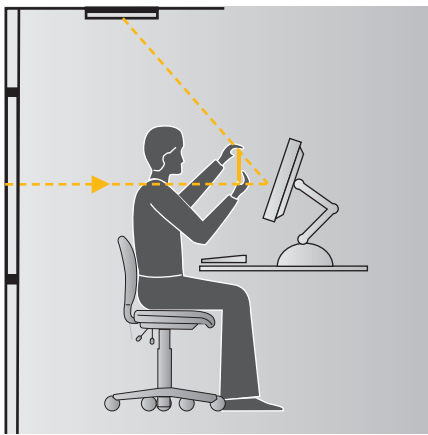

Figure 3.2 Assessing reflections

## Other issues related to lighting in the office

### Glare in a work area

Glare occurs when one part of an area is much brighter than the background or vice versa. For example, if a bright window is positioned behind a computer screen, the contrast (difference between dark and light) can be so great that the eyes have to constantly adapt to the change. This may cause eye fatigue and headaches, as well as decreased ability to view the screen. Glare can be identified by observation as well as complaints and comments from people working in the area. There are several ways to reduce glare in the office environment:

- control natural light from windows, e.g. venetian blinds enable people to adjust the light in their work areas;
- reduce the contrast between the foreground and background, e.g. the use of a slightly darker partition with a matte surface reduces the contrast between a computer screen and the surrounding area;
- reposition the workstation to reduce the light falling on the work surface; and
- reduce the general lighting to suit the task being performed.

### Reflections from a work surface

Light reflected from a surface can make it difficult to see what is on it. For example, it can be difficult to read a screen when light from artificial lighting or windows is reflected from it. To identify reflections, observe a work surface or screen and ask the operator if they have difficulty seeing their work due to reflections. Don't forget, light from windows changes during the day and with the seasons.

To assess reflections, hold a sheet of paper above a screen or place a mirror over the work surface to reveal the source of the reflections visible from the usual working position (see Figure 3.2). Check whether the mirror indicates overhead lighting or other sources of light as a problem for that work surface.

Reflections from screens have been reduced by the development of colour monitors, Windows-based systems, LCD screens and non-reflective screen surfaces. Additional controls for reflections include positioning the screen side-on to the main light source (see Figure 3.3). A light screen background also reduces difficulties caused by reflections. If these options do not resolve the problem, then consider moving the workstation to another position. This is particularly relevant where the screen is used for prolonged periods of time. These controls should be used in preference to the use of screen filters, which can reduce the quality of the screen display and require regular cleaning.

Annoying reflections can also occur in workplaces where there are highly polished floors or glass covered wall paintings. These issues should be addressed when planning and setting up an office. Even glossy paper documents can reflect light and become unreadable.

### Shadows across a work surface

Shadows can reduce the visibility of work, contribute to glare problems and cause the adoption of poor posture in order to view work (see Figure 3.4). A simple observation and test by holding a piece of paper above the viewing surface can indicate whether shadows fall over that work surface. Assessing the effect of shadows may be achieved by observing a person's posture. If a person is adopting a poor posture to read or see their work, then shadows may be a significant problem (also consider glare and reflections).

Increasing the number and spread of overhead lighting, repositioning work or redirecting lighting are the main ways of reducing shadows. Barriers to light falling on the work surface – for example, an overhead shelf – should be removed or relocated to reduce shadows. An adjustable task lamp may provide specific lighting where shadows are a problem, where light from a particular direction is required or when an increase in general lighting is not practicable. A task lamp can, however, create pools of light, causing the eyes to have to adapt rapidly when looking at the whole work surface, so the removal of barriers to light falling on the work surface is the preferred control measure.

# DESIGNING A HEALTHY AND SAFE WORKING ENVIRONMENT

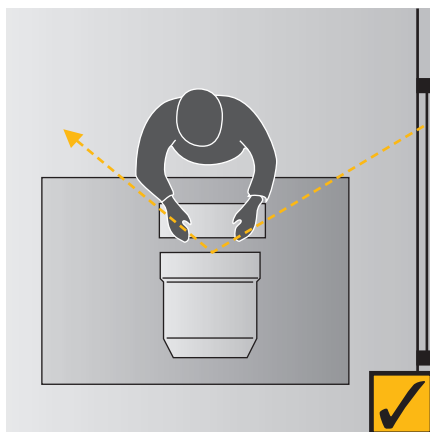

Figure 3.3 Preferred placement of the screen to reduce reflections



Figure 3.4 Poor posture may be due to inadequate lighting or uncorrected visual problems

## Posture and the visual environment

When people find it difficult to see what they are working with, it is common for them to lean closer to the object or to bring it (e.g. a document) closer to their eyes. In both cases, this may lead to an awkward posture.

People who report discomfort at work should be observed performing their usual duties. A well supported, neutral posture is less likely to result in discomfort. Where the person is not well supported by their chair, leans towards their work or adopts a posture as shown in Figure 3.4, there may be a problem caused by poor lighting, poor screen design or position, or uncorrected visual problems.

If lighting is contributing to poor posture, the location and all aspects of the lighting relative to the task need to be considered, for example:

- Is a shadow being cast over the work surface?
- Is there enough light for the task being performed?
- Are reflections or glare causing the person to adopt an unsatisfactory posture?

Where visual problems are thought to exist, advice should be sought from a medical specialist or optometrist (refer to Section 5).

## Visual fatigue

Eye muscles can become tired when constantly focused on close work. To identify if this is an issue in your office, ask people if they get tired eyes or other eye strain symptoms. To control visual fatigue, a change of focus, such as a view out of a window or to a picture along a hallway at a distance from the operator, can provide exercise to other muscles of the eyes while resting the tired muscles.

## Natural light

When identifying, assessing or controlling lighting issues in offices, you need to take into account the time of day and year, as this will affect the quantity and quality of natural light in a work area. This is particularly important when designing lighting systems.

Some of the office lighting issues may be caused by natural light entering a work area. By providing staff with control and adjustment of natural light, for example, venetian or vertical blinds, many of these issues can be addressed.

## Colour

Choice of colours can determine the mood of an environment and the level of reflection from a surface. It is recommended that ceilings have high reflectance, (reflecting around 80% of the light) and are usually white or off white. Walls should have 50 – 75% reflectance (subdued cool colours) and a gloss or semi gloss finish. Floors should have low (less than 20%) reflectance and therefore should be darker and not glossy. The use of colourful posters or non-reflective paintings can relieve monotony and provide visual relief.

## Flickering lights

Some lights can be a source of annoyance, particularly older fluorescent tubes which may flicker when malfunctioning. Regular maintenance will help control the effects of light flicker.

For further information about lighting in office environments, see references in Appendix D.

# DESIGNING A HEALTHY AND SAFE WORKING ENVIRONMENT

## NOISE IN THE OFFICE

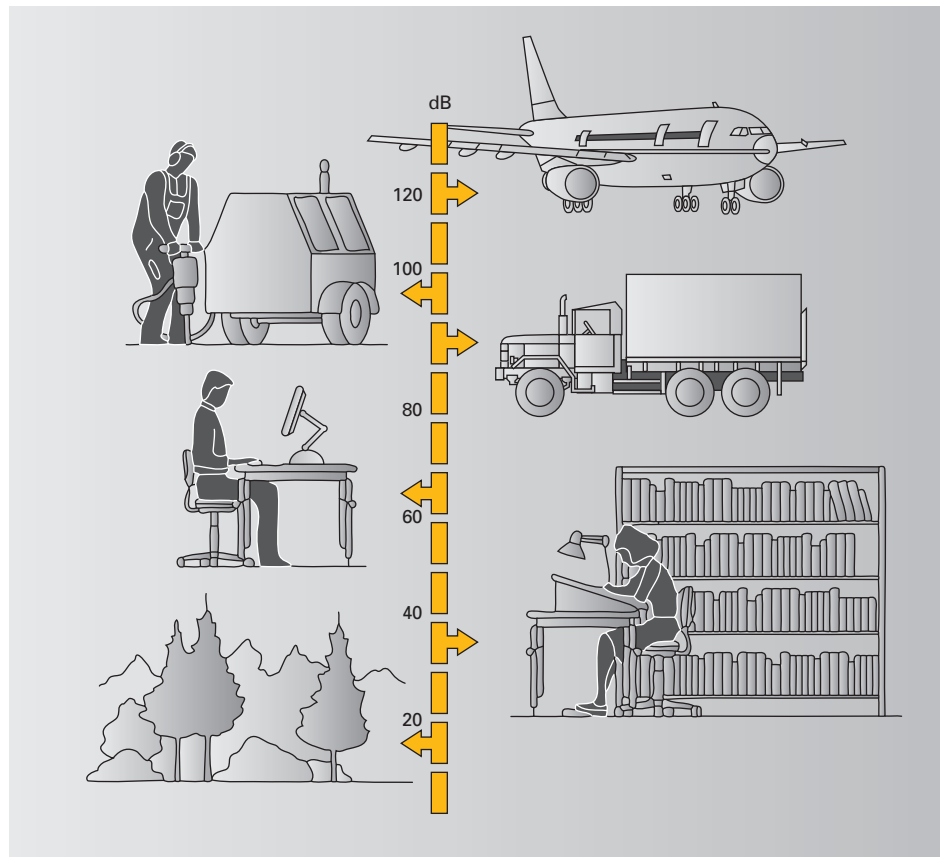

Figure 3.5 Common noise levels in decibels

### What is noise?

Noise is usually defined as any disturbing sound. In practice it is referred to as 'sound' when pleasant, and 'noise' when annoying. Typical noise levels in different work environments are depicted above (see Figure 3.5).

### Sources of noise

Noise within the office can originate from internal and external sources. Internal noise sources include office equipment (e.g. telephones, printers and photocopiers), people (e.g. conversations) and background noise generated by the building (e.g. from lifts and air conditioning). Background noise generally goes unnoticed unless there is a malfunction of equipment. In fact, some background noise is desirable as an absolutely quiet environment can be uncomfortable. External noise sources can include road traffic and general industrial noise.

Where noise has been identified as a hazard, such as in an industrial setting, the *Occupational Health and Safety (Noise) Regulations 2004* should be followed to identify, assess and control excessive noise levels. The *Guide for Assessing and Fixing Noise Problems at Work (2005)* gives assistance in complying with the Regulations.

Guidelines on appropriate noise levels for particular work environments may be found in *AS 2107: Acoustics: Recommended Design Sound Levels and Reverberation Times for Building Interiors (2000)*.

# DESIGNING A HEALTHY AND SAFE WORKING ENVIRONMENT

## Why is the control of noise in an office important?

Generally, the levels of noise in office areas are below those levels known to pose a risk to hearing. In offices, 'annoyance' noise is likely which may interfere with communication, annoy or distract people and affect a person's performance of tasks like reading and writing.

This can be costly for an organisation. Noise that prevents a person from understanding an instruction or warning signal may also be a risk to safety. For these reasons, it is important to consider what can be done to control unwanted noise in the office.

## Speech privacy

Some privacy during conversations is required, particularly in open-plan offices. This requirement should be built in at the design stage of the office layout, when the distance between people and orientation of workstations is determined. People should be able to have telephone conversations and perform work without the person next to them listening to every word.

Partitions are frequently installed to provide privacy between workstations. This involves considering the design of the whole environment including the size, construction and continuity of partitioning and all other surfaces in the office.

Expert advice should be sought when designing partitioning to provide speech privacy. For further information refer to *AS 2822: Acoustics: Methods of assessing and predicting speech privacy and speech intelligibility*.

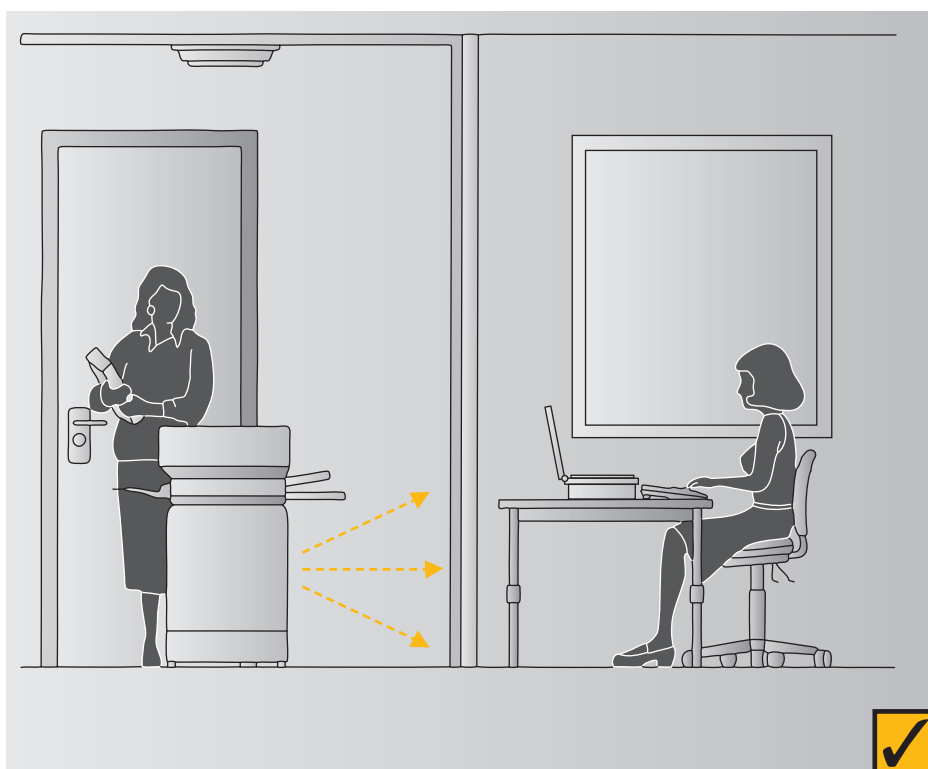

Figure 3.6 Noise from a photocopier controlled by isolating equipment in separate rooms

# DESIGNING A HEALTHY AND SAFE WORKING ENVIRONMENT

---

## Identifying disturbing noise in the office

To identify disturbing noise sources in an office it is best to ask the people working in the area a series of questions, for example:

- What noise is most disturbing (if any)?
- When does it occur?
- What effect does it have?
- How do you deal with disturbing noise?

This may be done using a general walk-through survey that includes interviewing people.

Where noise issues have been identified as a problem in an office environment, assessment and development of noise control measures should be undertaken. A qualified person should be consulted where specialist assessment or advice is required.

Noise control measures should be developed using the hierarchy of controls outlined in Section 1. The *Guide for Assessing and Fixing Noise Problems at Work 2005* can assist with this process.

If you need to control noise in an office environment, there are several things you can do:

- use a layout which separates noise generating activities or equipment from tasks requiring concentration;
- isolate noisy equipment such as printers or photocopiers by placing them in separate rooms (see Figure 3.6);
- use sound-absorbent materials, including suitable floor coverings, wall panels, ceiling panels and dividing screens. Installation of barriers should also take into account the effect this may have on ventilation and any sense of isolation it may cause with staff;
- provide acoustic-grade dividing screens to reduce conversation noise. Studies have found that partitions with sound absorbing panels of at least 1,600mm height are required to have any effect on the transfer of sound between workstations. These panels need to be used in conjunction with other sound absorbing surfaces – floors, walls and ceilings – to be effective. In an open-plan office compromises may be made to allow communication between workstations by using 1,200mm height partitions between employees and 1,600mm between work sections;
- select equipment with the lowest noise specifications practicable;
- install noise barriers – including double-glazed windows, solid walls and fences – to reduce external noise sources;
- lower the volume setting on a disruptive telephone. This is a simple way to reduce existing noise levels;
- adopt administrative controls such as encouraging employees to use meeting areas away from work areas for conversations;
- use masking sound, i.e. electronically generated background noise that is deliberately introduced to mask or cover up intrusive noises. It is best to control unwanted noise rather than try to mask it. Masking has generally been found to be an unsatisfactory way of dealing with unwanted noise (consult an expert on this issue); and
- orient workstations so that one person does not use the phone in a direct line to the ear of the person in the next workstation.

# DESIGNING A HEALTHY AND SAFE WORKING ENVIRONMENT

## THERMAL COMFORT AND AIR QUALITY IN THE OFFICE

### Thermal comfort

Comfort is influenced by clothing, the job being undertaken, temperature, humidity and air flow. People may feel uncomfortable if the temperature within an office is either too low or too high. High humidity can create a stuffy, sticky atmosphere and contribute to feelings of tiredness. There are considerable individual differences between people regarding what is comfortable and it is unlikely that a single temperature or level of humidity will suit everybody.

For further information on thermal comfort, refer to Comcare Australia's *Air Conditioning and Thermal Comfort in Australian Public Service Offices (1995)*.

### Identifying thermal comfort issues

To identify thermal comfort issues in office environments, ask the people working in the area a series of questions like:

- Do you find the atmosphere hot, cold, stuffy or draughty?
- When do you notice these conditions?
- What effect do these conditions have on your work?
- How do you deal with them?
- Where do you notice these conditions?

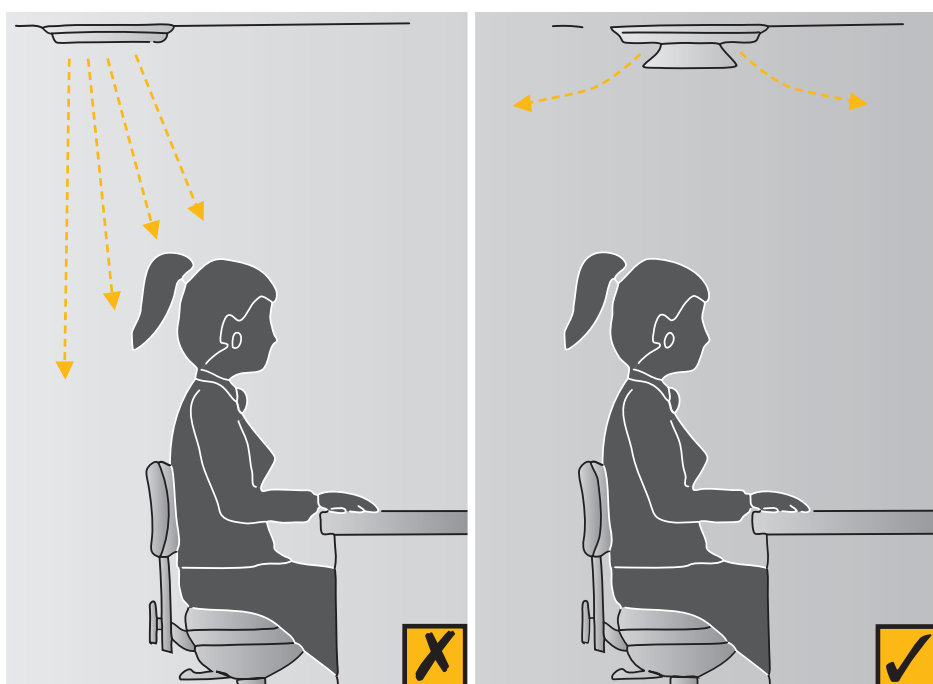

Figure 3.7 Direct air flow away from people

### Assessing thermal comfort issues

Where thermal comfort is an issue, there will usually be a history of complaints from staff.

Where problems are identified by many staff, thermal comfort issues should be assessed by an appropriately qualified person and control measures developed in consultation with employees.

# DESIGNING A HEALTHY AND SAFE WORKING ENVIRONMENT

---

## ***Controlling thermal comfort issues***

Some general suggestions for improving thermal comfort include:

- regulate air conditioning for temperature and humidity;
- avoid locating workstations directly in front of or below air conditioning outlets;
- install deflectors on air vents to direct airflow away from people. These measures will help prevent staff being annoyed by draughts (see Figure 3.7);
- control direct sunlight (radiant heat) with blinds, louvres and window treatments;
- minimise draughts and thermal differences between the head and the feet (thermal gradients); and
- ensure adequate air flow. Feelings of stuffiness can result when air flow is low, and draughts occur when air flow is high. An air flow rate of between 0.1 and 0.2 metres per second is desirable.

## **Air quality in offices**

Air in offices may be contaminated by several different sources, including odours and micro-biological and chemical contaminants. In an office environment, the quality of the air is often controlled through an air conditioning system. A building's air conditioning system can be considered its lungs. The function of such a system is to draw in outside air, filter, heat, cool or humidify it and circulate it around the building. The system expels a portion of the air to the outside environment and replaces this expelled portion with fresh or outside air.

Guidelines on appropriate air quality standards for the office environment are contained in the relevant Australian Standards, particularly *AS 1668.2: The Use of Ventilation and Air Conditioning in Buildings: Ventilation Design (2002)*. There are several air contaminants which can lead to health problems for workers in offices.

## ***Legionnaire's disease***

Legionnaire's disease is an infection caused by exposure to legionella bacteria. Infection can often be traced to exposure to mists of airborne droplets carrying the bacteria. These may be related to contaminated air conditioning cooling towers and warm water systems. Other sources may include aerosols from spa baths or potting mix.

Effective prevention of exposure to legionella is achieved through appropriate design and maintenance of air conditioning systems. In Victoria the law requires:

- cooling towers to be registered;
- a risk management plan to be in place; and
- regular testing and maintenance of systems.

Legislation includes the *Building (Legionella) Act 2000* and the *Health (Legionella) Regulations 2001*, which are administered by the Department of Human Services. Comcare's *Approved Code of Practice on Indoor Air Quality (2002)* contains guidance on prevention of legionnaires' disease.

## ***Sick Building Syndrome***

Sick Building Syndrome (SBS) refers to a situation where a proportion of people complain of symptoms of discomfort such as a headache, eye, nose or throat irritation, fatigue, dizziness or nausea while inside a building and the symptoms go away upon leaving the building. Instances of SBS are rare and may be related to psychosocial factors in the workplace as well as poor air quality. Where air quality problems exist or SBS is thought to be a problem, specialist advice should be sought.

## ***Ozone***

Ozone is a gas produced in small amounts by electrostatic photocopiers. Under normal circumstances, the concentration of ozone is not sufficient to cause symptoms such as itchy eyes or illness. Most older photocopiers now have activated carbon filters fitted to decompose ozone. It is best to store photocopiers in a well-ventilated area. For more information regarding ozone, refer to WorkSafe Australia's *Office Copying Machines (1989)*.



# DESIGNING A HEALTHY AND SAFE WORKING ENVIRONMENT

---

## CHECKLIST: DESIGNING A SAFE AND HEALTHY WORKING ENVIRONMENT

**Have environmental issues been assessed and where necessary controlled as far as is practicable, including:**

- Lighting (such as adequate amount, quality, colour of light and control of glare, reflection, flicker and shadows)?
- Noise (e.g. disturbing or nuisance noise, lack of speech privacy)?
- Thermal environment (such as heat, cold, stuffiness or draughts)?
- Air quality (e.g. control of air conditioning systems, office equipment outputs)?

# 4

## OFFICE LAYOUT, WORKSTATIONS AND EQUIPMENT

This section looks at the general principles of office layout, workstation design, seating, desks, workbenches and storage systems. Consideration is also given to health and safety issues related to technological changes in office equipment and tools.

### OFFICE LAYOUT AND DESIGN

An important feature of modern office design is the need for flexibility in office layout, furniture, equipment and the environment to suit the needs of the users and the work they perform. Design must be taken into account in the early stages, not just when a building is being outfitted. See WorkSafe Victoria's *Designing Safer Buildings and Structures: a Guide to Section 28 of the Occupational Health and Safety Act 2004*.

#### Floor space

Provision of adequate space in an office to enable a person to operate effectively is essential. There are three types of space that need to be considered:

- primary space – amenities, meeting rooms, lift lobbies and similar areas;
- secondary space – corridors and storage; and
- tertiary space – space required in a workstation to accommodate a desk, chair, drawers, filing cabinet and other necessary equipment.

The Building Block approach is one method used to determine the amount of space required by personnel. This is based upon a functional analysis of their needs, that is the tasks they perform in their jobs. This method recommends a minimum of 6 square metres per person for tertiary space and additional space for secondary and primary space requirements. It enables planners to provide enough space for all the requirements of technical people working in offices including clerical and administrative staff. AS 1668.2 (2002) recommends an overall 10 square metres per person for offices, including primary, secondary and tertiary spaces. This standard relates to the ventilation of the building. The important thing to design for in all circumstances is the functional needs of the employee.

#### Floor surfaces

Generally carpet is preferred in office areas to provide a comfortable walking surface and to reduce noise, reflected light from polished floor surfaces and the risk of slips and falls. Selection of wool mix carpets reduces the build-up of static electricity which can give a mild electric shock. Carpets should be properly laid without loose edges or ripples and should be well maintained. Where there are tasks requiring pushing and pulling wheeled equipment, carpet should be low profile to prevent high force manual handling.

# OFFICE LAYOUT, WORKSTATIONS AND EQUIPMENT



Figure 4.1 Reception desk

## Walkways

Walkways should provide safe access and egress at all times. The use of walkways for temporary storage can introduce tripping or falling hazards and block emergency exits. The through traffic using walkways can be a source of noise and distraction for staff positioned near them. Walkways near office workstations should be bordered by sound absorbing panelling to help reduce noise.

## Partitions

Partitions are used to divide workstations and provide visual and auditory privacy. They can also reduce unwanted distractions, provide a background visual surface for computer screens, reduce contrasting light intensities, help direct a person's line of sight towards an external window for relief of visual fatigue, and control external and reflected light. Partitioning can cast shadows and reduce levels of light if not appropriately designed or installed. Refer to Section 3 for additional information.

## Storage

Storage facilities such as filing cabinets, lockers and shelves often sit on the border of a walkway. When choosing the location of this equipment it is important to consider what other activities occur in the area. For example, a filing cabinet requires approximately 1.2 metres of space in front of it to enable someone to access a fully opened bottom drawer. If this projects into a frequently used walkway it becomes an obstruction and a hazard will be created.

## Function of the space

The size and layout of a work area should accommodate the equipment and the needs of the users. Where equipment such as photocopiers, faxes and printers are used, there is a need to accommodate the equipment and allow for additional traffic and general activity.

## Eating and relaxation facilities

A separate space, with access to hot water and a sink, should be provided for meal and tea breaks and to allow employees to take rest breaks away from their work desks.

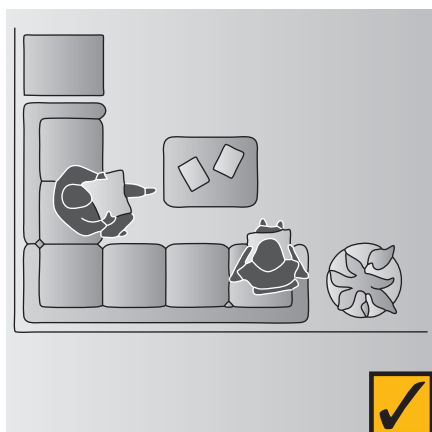

Figure 4.2 Reception/waiting area (not to scale)

## WORKSTATION DESIGN

The core components of an office workstation include a desk, a chair and the equipment used to perform office tasks. Other furniture may include reception desks, paper storage, collation benches and workbenches next to office equipment such as photocopiers, faxes and printers. In the design of office workstations flexibility and adjustability are the key design issues. Individuals can then control how their workstation is set up and organised to meet the changing demands and variety of tasks they perform.

### General principles

The design of a workstation should be directed by the range of people who may use it, the tasks they perform and the type of equipment to be accommodated.

### Adjustability

In addition to adjustability to accommodate the different sizes and statures of people, workstations need to be flexible and large enough to accommodate the growing range of tasks performed and equipment used in offices. The workstation should be easily adjustable and the adjustment mechanism should not create a risk from manual handling. Electric adjustment is the most appropriate.

### Posture and movements

The shape and adjustability of a workstation influences the postures people adopt while working. The location and type of equipment used at the workstation also influences the range of movements performed during work. The workstation then is the means of placing people in the best position to enable them to effectively perform their tasks and use their equipment in comfort.

# OFFICE LAYOUT, WORKSTATIONS AND EQUIPMENT

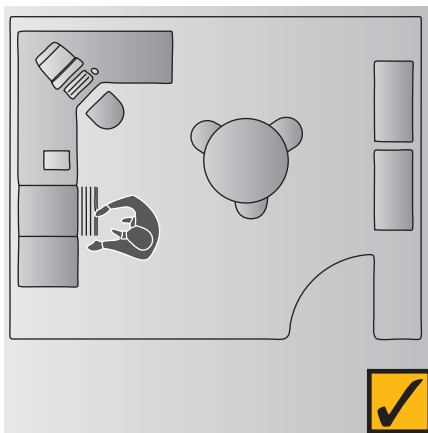

Figure 4.3 Typical manager's workstation

## Workstations in the office

A variety of workstations are used in offices to meet the needs of computer users, including:

- data entry or customer service users – engaged in continuous input tasks such as keying numerical data;
- interactive users – performing a variety of tasks with a considerable proportion of the day interacting with a computer; and
- casual users – using computers on an occasional basis or infrequently during the day.

Workstations should also allow for non-computer tasks, or separate workstations should be available for non-computer work.

In addition to the type of computer usage, the design of a workstation is influenced by the variety of people required to use it:

- multi-user workstations need to be adjustable to meet the needs of different users; and
- single-user workstations need to be adjusted initially to meet the particular dimensions and preferences of the individual. Even after this initial adjustment, the user's tasks or needs may change requiring further workstation adjustments.

Possibly the most common workstation found in the office combines provision for computing and general administrative duties.

## The computer and administrative workstation

This workstation usually involves an adjustable chair, a desk, a footrest if needed, desktop computing equipment including a keyboard, a mouse, a hard disk drive and a screen, a document holder, a telephone, and related furniture and equipment. As new technologies and tools are introduced, flexible workstations are required to accommodate the job design changes that occur as a result (see Figure 4.4).

A guide to setting up your workstation can be found in Appendix A.



Figure 4.4 The computer and administrative workstation

## CHAIRS

It is essential that office seating is comfortable, appropriate to the task being undertaken and easy for the operator to adjust. The often held view of the activity of sitting is that people maintain a fixed posture for long periods of time, however, when performing a range of activities, people tend to adopt different positions and postures while seated. This is desirable as it provides variation in loading of the thighs and back and in general can improve seating comfort.

## Adjustable office chairs

A chair is the main item of a workstation that provides adjustability for comfort and enables the work heights to be controlled. Key factors to consider when determining if the chair is appropriate for the person and the job are listed as follows:

- it should be adjustable to the task and be easily adjusted from the seated position;
- the seat should be height-adjustable, preferably utilising a gas lift for ease of adjustment;
- the seat should have a curved front edge, to minimise pressure on the underside of the thighs (see Figure 4.5);
- the seat should be able to tilt slightly backwards or forwards;
- it should have a supportive backrest that is adjustable in height, angle and depth;
- both the seat and backrest should be covered by cloth or some other type of material that breathes;
- it should have a five-star base for stability; and
- armrests are optional; they help decrease the forces on the shoulders and back during rest from keying. If provided, armrests should preferably be adjustable in height.



Figure 4.5 Adjustable office chair

# OFFICE LAYOUT, WORKSTATIONS AND EQUIPMENT

---

In general, chairs are designed to fit 90% to 95% of the adult population. People outside this range, because they are tall, short or large, may need seating that is tailored to their needs.

Chairs should support the body in a way which minimises awkward postures and provides comfort, however, chair positions may need to be changed often. No chair can provide a perfect position for long periods and it is important to change postures and get up from a chair many times during the day's work. Setting up an adjustable chair for optimum support is shown in Appendix A.

## **Alternative seating**

Some forms of alternative seating are designed to enable people to sit with the hips at an angle that is believed to reduce pressure on the lower back. These types of seating are not necessarily better or worse than conventional adjustable office chairs, but may not provide the optimum support in a workplace where many hours of the day may be spent in sitting.

There are no current guidelines or design standards for alternative chairs. They should not be used for constant sitting and conventional chairs are also required in the office environment. See *Fitness Ball not Suitable as a Chair (WorkSafe, 2005)*.

Different seating is sometimes chosen by personal preference e.g. by someone with lower back pain or to look good. Some examples are:

- the 'kneeling' chair, a forward tilted chair base with knee support;
- the 'sit-stand' or 'saddle' chair with a tilted base for 'propping' on;
- the 'physio' or 'fit' ball, an inflated ball which encourages constant small changes in posture to maintain balance; and
- executive chairs, which, as the name suggests, are designed as status furniture for executives. Their design often provides little in the way of adjustability and seat and backrest design to give support. As most senior managers use computer equipment as a core part of their daily work, executive chairs should include the adjustability and features listed above.

An organisation may choose not to allow alternative seating unless it has been assessed for risks to users or is required by a medical or rehabilitation plan.

There are limitations in using these chairs in the workplace, e.g.:

- the seat is often not able to be adjusted to accommodate different leg lengths or the angle of seat. Some models of the 'kneeling' and the 'sit-stand' chair do provide adjustments and include an adjustable backrest;
- their use relies on the adoption of a prescribed posture, maintaining the natural curves in the back. Users may need to gradually increase their use of this seating to enable muscles to adapt to the different postures;
- although some of these postures may be preferred for short periods, in general these forms of seating do not provide lumbar support, which leads to the back and abdominal muscles working for long periods of time to maintain the adopted posture if used as a work chair;
- getting on and off and sitting on seats such as the 'kneeling' chair and 'fit' balls may be awkward, particularly with some types of clothing, and caution is needed; and
- where there is no stable mobile chair base, a person cannot easily move around the workstation as their leg positions are often constrained. They must rely on back and arm strength to move.

Although these chairs allow an upright posture when facing a task, there is a greater degree of reaching, bending and twisting required when accessing other parts of the workstation and there may be risks from loss of balance and extreme postures.

# OFFICE LAYOUT, WORKSTATIONS AND EQUIPMENT



Figure 4.6 Kneeling chair



Figure 4.7 Seat height and footrest adjustment

## **How to correctly adjust an office chair**

- The chair height should be set so that the thighs are approximately horizontal and the feet rest comfortably on the floor.
- Combine chair and desk adjustments to position the work at elbow height. Where writing and mouse and keyboard tasks are performed, it may be necessary for the chair height to be adjusted slightly between these two tasks (that is, raised for keying or mouse work and lowered for writing).
- If the chair height is correctly set but the desk is too high, either lower the desk height or raise the height of the chair and use a footrest to make up the height difference (see Figure 4.7).
- The backrest should be adjusted so that its convex curve fits into the curve of the lower back, centred about waist level. A slight backwards tilt of the backrest or forward tilt of the seat will allow an increase in the angle at the hip. This will decrease the force on the lumbar spine.
- If the thighs are wedged between the chair and the under surface of the desk, or the knees bump into the front of the desk then either the desk is too low, the chair is too high, the desk top is too thick or the user is too tall for the chair and desk. An ergonomist can give advice in this situation (see Appendix D).
- Small adjustments can be made as often as changes in tasks to adopt the most appropriate posture for the task.

## **How to decide if you need a footrest**

This will depend upon whether your desk is at the required height once you have adjusted your chair to suit your needs. If the desk is too high and it cannot be lowered, then raise the height of the chair and use a footrest to raise the height of the floor by the same amount. Footrests should have height and angle adjustability and be large enough to permit some movement while supporting the feet. A footrest should not be so big that it clashes with the chair base. Using a footrest limits mobility so it is preferable to have full adjustability of the desk and chair to avoid the need for a footrest.

## **How to decide if you need armrests**

Armrests are designed to allow people to support themselves when getting up or sitting down. They are suitable for people who perform a variety of tasks at a workstation, move frequently to and from their chair or sit back in their chair to talk to visitors. Armrests are less suitable for keying work. If the elbows are fixed on the armrests they can cause the shoulders to be raised into an unnatural posture. The desk surface can be used to support the forearms and reduce the effort of supporting the arms. Armrest designs should not limit forward chair movement by touching the desk.

## **Choosing between castors and glides**

Castors allow chairs to be easily moved forwards and backwards, however, they are not suitable for use on non-carpeted surfaces unless fitted with friction brakes. Misuse of a chair with castors, such as standing on it, is hazardous. Glides or castors with friction brakes should be used where chairs do not need to be moved – for example, on visitors' chairs – or where hardfloor surfaces exist. Care must be taken not to provide slippery mats at desks where chairs with castors are in use.

## **Purchasing chairs**

Before purchasing new chairs, it is important to assess use of the chairs and the design features needed. WorkSafe Australia's *Ergonomic Principles and Checklists for the Selection of Office Furniture and Equipment (1991)* provides guidance for the selection of chairs, and the requirements for adjustable height chairs can be found in AS/NZS 4438 *Height Adjustable Swivel Chairs (1997)*. It is the responsibility of suppliers to advise if chairs meet the Australian Furniture Research and Development Institute (AFRDI) Standards. Trial use of chairs in the office is advisable prior to purchase.

# OFFICE LAYOUT, WORKSTATIONS AND EQUIPMENT

---

## DESKS AND WORKBENCHES

### ***General design considerations***

The main factors to consider when choosing desks include:

- tasks to be performed;
- equipment and resources to be accommodated; and
- adjustability to meet the range of different sizes of the users.

Refer to the WorkSafe Australia publication *Ergonomic Principles and Checklists for the Selection of Office Furniture and Equipment (1991)* and AS/NZS 4443 *Office Panel Systems – Workstations (1997)* for more detailed information on office desks and workstations.

### **Types of desks**

#### ***Freestanding height-adjustable desks***

These desks are designed to raise and lower the desk surface so that the user can position work at the most comfortable height. They are suitable where different staff use the same desk (multi-user) or where a range of different tasks are performed at the same desk (multi-task).

The length and depth of the desk depends on its use. For example, a computer screen needs to be located at least an arm's length from the user when sitting in a keying position and the depth of the desk will need to take into account the depth of the screen and the distance required from the user. Where a freestanding desk is used against a wall, it may have to be moved away from the wall to allow the screen to be placed at the rear of the desk and to achieve a suitable distance from the user.

#### ***Freestanding fixed-height desks***

These desks provide limited flexibility for the user. Chair adjustments are relied on to meet the user and task requirements. In some situations the desk can be modified (raised or lowered permanently) by a trades person; however, this renders the desk unsuitable for use by people of different physical dimensions.

#### ***Split desks and keyboard platforms***

Some desks used for computing work have an adjustable section to hold a keyboard. These designs limit the range of tasks that can be performed at these desks. If they are used, the selection of a split desk should match the tasks that need to be performed. Adjustment mechanisms located in the leg space under the desk may be hazardous to the knees. A drop down keyboard shelf provides inadequate space for using a mouse, forcing the operator to raise the arm up from the side to use the mouse. Keyboard platforms that slide out from under the desk are not recommended as they cause an increase in the reach distance to other equipment on the desk and generally provide inadequate space for the use of a mouse.

#### ***Corner workstations***

In these workstations, the desk is usually designed to extend along two sides of the partitioning so that it occupies the corner. The corner section usually has a bridging section that is at 45 degrees to the two sides. In some cases the bridging section connects the two sides with a curve to accommodate larger computers, which can be placed in the corner section to take advantage of the increased depth created by the angle. Placement of these larger computers, such as some design and engineering systems, is crucial as they are much deeper than conventional screens and, if placed on one of the side sections of the desk, would be too close to the user.

Corner workstations can be an efficient use of space and often have built-in cable housing. Care should be taken to choose a workstation that does not impose limitations on adjustability or the ability to choose a layout if needs change.

# OFFICE LAYOUT, WORKSTATIONS AND EQUIPMENT



Figure 4.8 Incorrect standing-height bench

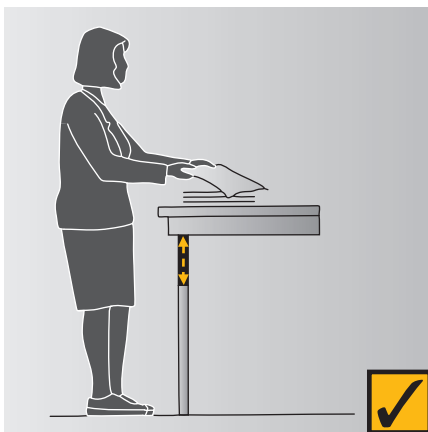

Figure 4.9 Correct standing-height bench

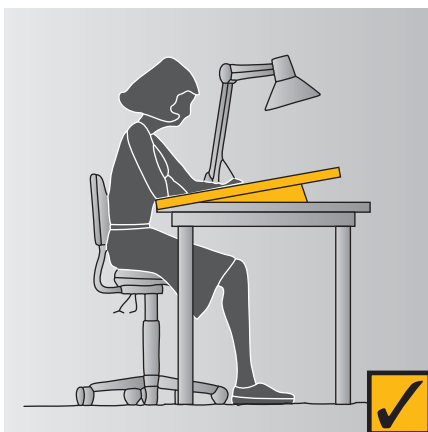

Figure 4.10 Angle board

## Standing-height benches

Typical tasks that require a standing-height bench include sorting mail, collating documents, and binding and receiving incoming goods. Drafting workstations may be required for tasks involving drawing or preparing artwork. In some cases, standing-height benches or drafting workstations are used by staff whose capacity to sit for prolonged periods is limited (see Figure 4.9).

Ideally, standing-height benches should be adjustable to accommodate the height differences of the range of people using them. In general, a standing-height bench needs to be between 850mm and 950mm from the floor, but this will depend on the type of task performed. The tasks performed should determine the amount of space required on the bench top. Generally, the length ranges from 1.2 metres up to 3 or 4 metres long. The depth generally ranges upwards from 600mm depending on the tasks to be performed.

Benches are less suitable for seated work, where a desk should be used. Benches usually have limited or no space for the knees, causing a twisted posture. High chairs can be unstable and do not enable a person to place their feet comfortably on the floor or a footrest. Some high desks provide a continuous foot platform to allow for foot support and movement at the workstation.

## Sloped work surfaces

Some desk designs incorporate a sloped surface section. Otherwise an angle or sloped board enables the angle of a work surface to be adjusted. It is usually placed on top of a desk and used to raise the height and angle of documents so that the neck is in a more upright posture while reading and writing for prolonged periods (see Figure 4.10).

Eye strain can be decreased by positioning the document at a right-angle to the line of vision. The angle board needs to be adjustable and large enough to support several documents.

## General features of desk design

A good desk should have:

- rounded corners with no sharp edges;
- good access for legs with no obstacles under the desk to cause discomfort and possible injury (see Figure 4.11);
- a flat, smooth surface for ease of writing, of a neutral colour with a non-reflective finish; and
- adjustability to fit most users (AS/NZS 4442 *Office Desks – 1997* recommends a range of adjustment for seated tasks of at least 150mm, from 610mm to 760mm in height, easily adjustable from the seated position).

## Tips and hints

- When selecting desks and other workstation equipment and furniture, consider:
  - tasks to be performed;
  - type of equipment and materials to be used;
  - adjustability; and
  - number of different users.
- Where possible, split desk designs should be avoided as these limit the options for placing equipment and can cause secondary hazards if the user's legs strike the adjustment mechanism.
- The space under the desk should be free of obstacles to enable safe and comfortable location and movement of the legs.
- Where possible, arrange trials of a variety of desks from suppliers. This allows you to select desks suitable for the variety of tasks performed at each workstation.
- Consider modular workstations that permit flexibility in design and layout.



# OFFICE LAYOUT, WORKSTATIONS AND EQUIPMENT

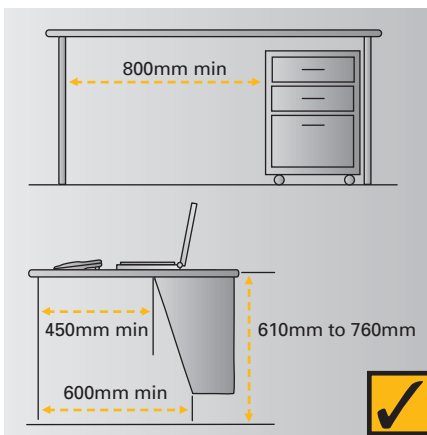

Figure 4.11 Knee clearance dimensions for office desks (from WorkSafe Checklist for Ergonomic Design of Office Desks)

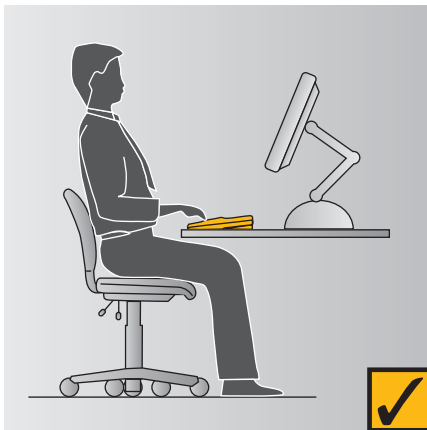

Figure 4.12 Keyboard placement in front of the operator



Figure 4.13 Neutral position while using a mouse

## DATA INPUT DEVICES – KEYBOARDS, THE MOUSE AND OTHER POINTING DEVICES

### Manually operated input devices

Of the wide range of input devices used with computers, the ones most commonly used are the keyboard and the mouse. The way in which these devices are used needs to be carefully considered, as repetitive use over an extended period can lead to discomfort and injury.

### Keyboards

Use of keyboards in offices varies according to the task. Generally, the more a keyboard is used, the higher the risk of discomfort. This does not mean that people should not use a keyboard extensively in their work. However, job design (including variation in tasks and ability to take breaks from repetitive keying) and adjustable equipment and furniture are important considerations for people who use computers for extensive periods of time.

Health and safety issues also need to be considered for notebook and laptop computers, and small keyboards such as palm types (see also page 42 – Notebook and laptop computers).

To reduce keyboard work, voice recognition and handwriting recognition software can be appropriate for some users.

### Placement of the keyboard

The keyboard should be aligned with the computer screen (or document holder if it is the major viewing surface) and directly in front of the user so that there is no need to twist or rotate to use it. It should also be placed near the front edge of the desk to reduce the distance required to reach it.

Reference documents should be placed between the keyboard and the screen or directly alongside the screen. They should not be placed between the keyboard and the front of the desk because this places the keyboard too far away from the user and contributes to poor posture.

### Keyboard adjustment

Where possible, the feet at the rear of the keyboard should be maintained in a lowered position to minimise the height and angle of the keyboard and reduce unnecessary loading of the shoulder and wrist muscles. There should be sufficient space on the desk so that the keyboard can be easily moved away to create room for another task when it is not in use.

### Split keyboards

Split keyboards are split in half and angled to enable the joints of the upper limbs to adopt a neutral posture while keying. Keyboards of this type are available commercially but their use is currently not extensive.

### Separate numeric pads

As many users do not use numeric pads attached to keyboards, providing a keyboard without a numeric pad can reduce the keyboard width and allow the mouse to be operated closer to the user.

### The mouse

The mouse can come in a variety of shapes and sizes, with features such as a scrolling wheel. The key criteria for the use of a mouse should include:

- placement of the user's hand and upper limb in as neutral a posture as possible during use;
- support of the weight of the arm by the desk and not by the user;
- keeping the wrist flat during use;
- allowing fingers to rest on the push buttons between actions; and
- ensuring mouse design fits the size of the user's hand.

# OFFICE LAYOUT, WORKSTATIONS AND EQUIPMENT



Figure 4.14 Thumbs stretched to reach a trackball or glide point

## ***Use of a mouse***

It is good practice to learn to use a mouse with each hand and periodically change between the hands to reduce or prevent discomfort through prolonged use. Many people are reluctant to try to share the use of the mouse between hands, but if practised the skill to alternate between hands is often developed.

## ***Preventing discomfort when using a mouse***

Sustained hand postures during use of the mouse can be reduced by greater utilisation of keyboard shortcuts, changing hands and by moving the mouse towards the middle of the desk and pushing the keyboard back, if the task is primarily a mouse activity.

If used, a mouse mat should be placed immediately beside the keyboard so that reach distance and the risk of discomfort is minimised.

## ***Ease of use and maintenance of the mouse***

If the cursor is difficult to control, cleaning the mouse ball and its contents with a suitable solvent (consult the manufacturer's instructions) and cleaning the mouse pad may make it easier and quicker to use. The computer's operating system can also be used to alter mouse settings, such as speed and acceleration. An optical mouse, which does not have a ball underneath, can be used.

## ***Alternative cursor controls***

Alternatives to the standard mouse are designed to change hand and arm postures and increase efficiency. They include a diverse group of operations, including rollers, pens, balls, pads and glide points. The main difference between a mouse and these devices is that the hand and arm remain stationary while the wrist is at an angle and the fingers or thumb stretch. For long periods of use this way may cause finger, thumb or wrist discomfort. Lifting the hand off the keys while operating the pointing devices is preferable.

## **OTHER OFFICE EQUIPMENT**

### **Telephones**

People in offices use telephones to varying degrees. Telephones should be situated so that the user can perform simple tasks, such as taking notes, without the need to twist or support the telephone on the shoulder. A long enough cord is usually sufficient to allow flexible positioning of the telephone to suit the user. Headsets should be used where the person has to regularly perform tasks such as keying information or taking orders while using the telephone, or does dedicated telephone work, such as in a call centre. Use of a headset can assist in reducing the reach distance and the frequency of handling the receiver and eliminate awkward neck postures.

When a headset is being purchased, the surrounding environment and the need for the user to attend to other signals should be considered when deciding on the design and number of ear pieces.

A hands-free phone may be used for occasions such as a teleconference, but they are not suitable in an open office environment.

### **Staplers**

Staplers are designed to be used on a bench. With occasional use they do not present a hazard. If thick documents are to be stapled, a stapler appropriate for the task should be used to reduce the need for high levels of force to perform the task. If a stapler is used repeatedly for a prolonged period of time, this may be fatiguing for some people, particularly if they perform the task while seated or the table or bench is at an unsuitable height, requiring them to elevate their shoulders. High usage of a stapler may also result in excessive compression forces to the palm of the hand.

Electric staplers should be used where stapling is frequently required for prolonged periods. The design of an electric stapler should guard against fingers being injured during use and safe work procedures should be implemented.

# OFFICE LAYOUT, WORKSTATIONS AND EQUIPMENT



Figure 4.15 Document holder designs – A4 and A3 sizes are usually available

If use of the stapler is assessed as a risk, control options such as the use of alternative attachment devices (for example, binding, bulldog clips) or the provision of a larger manual stapler or an electric stapler should be considered.

## Staple removers

For occasional removal of staples, a small pincer type of staple remover is commonly used in the office. Where this task is identified as a risk, such as highly repetitive staple removing, a lever operated device should be considered.

Removing staples by hand should be avoided. To control the risks associated with staple removing, such as stabbing injuries, some large organisations now ask customers to return documents unstapled. Alternate binding mechanisms should also be considered.

## Letter openers

The use of letter openers usually doesn't present a problem in offices until the level of use increases beyond that used to process personal mail. The slim handle of a knife-like letter opener can be difficult to grasp. A larger handle enables a more solid grip. Repeated handling of mail and the forceful movement required to open mail can be avoided by the use of mechanical letter openers.

## Hole punches

A range of hole punches are available – from small lever operated to large electric drill types – and their use should be matched to the thickness of the documents being processed. Longer lever arms enable thicker documents to be punched by a manual hole punch with less force required by the operator. Many photocopiers have a hole punching function. Because of the forceful nature of this work it is preferable to use hole punches at a standing-height bench (see Figure 4.9).

## Pens and writing implements

Despite the major office tool being the keyboard, a wide range of writing tasks exist in the office. The standard ballpoint pen is suitable for infrequent general use, however, easy ink-flow pens usually require less force to grip and write. A thick grip pen or a triangular attachment to the pen can reduce the overall force required to grip the pen.

Writing for long periods may result in hand or forearm soreness. If this occurs, these periods may need to be reduced or interspersed with other activities.

## Wrist or forearm rests

Wrist or forearm rests are incorporated in some keyboard designs or provided to support the forearm during pauses in keying work. In practice, however, people often use the rest while typing, causing the fingers to reach to the keys rather than the whole arm generating that movement. This may cause strain of the muscles and tendons at the wrist. The use of a wrist rest also places the keyboard further away from the user, which can increase sustained load on the shoulders and cause discomfort or muscular strain. Wrist rests should not be required if a workstation has been adjusted to meet the needs of the user (refer to Appendix A).

## Document holders

Reading source documents resting on the surface of the desk for prolonged periods may cause neck and shoulder strains through the adoption of poor posture. Document holders are designed to hold reference material so that they can be positioned according to the visual needs of the user. An example is shown in Figure 4.15.

Upright movable document holders can be positioned next to the screen at the same height and visual distance from the user as the screen. A-frame or flat document holders can be positioned between the screen and keyboard to support multiple or bulky papers. A-frames need sufficient adjustment to raise, lower and angle documents to accommodate different screen heights.

# OFFICE LAYOUT, WORKSTATIONS AND EQUIPMENT

---

## Monitor stands

Screens may need to be raised above desk height to reduce postural strain to the user's neck muscles. The top of the screen should generally be level with the user's horizontal eye level and at a distance of approximately one full arm length when the operator is sitting in their usual position for keying (see Figure A.11). A variety of stands are available to raise screens above desk height. Fixed-height stands tend to be suitable for single user workstations where the height of the monitor suits the individual's needs and the employee performs varied tasks, including keying, throughout the day. Adjustable height and movable stands can be used to meet the needs of a variety of users or to provide space for other tasks an individual may perform over the day.

## Notebook and laptop computers

Laptop computers were designed for short-term or mobile use. The portable nature of the laptop and notebook results in them being used in a wide variety of situations and settings where there is limited capacity to adjust the desk. This can result in the work height being unsuitable. Lack of adjustability of the screen and keyboard can result in the arms being held too high or the neck bent to view the screen. If this position is adopted frequently or for long periods, discomfort may result. If the screen is tilted upwards to reduce the need to bend the neck to view the screen, reflections can be a problem with some screens.

The adverse effects of working on a laptop computer may be prevented by:

- docking the laptop or notebook into a desktop computer at an adjustable workstation;
- connecting into existing computing equipment, such as the screen, keyboard and mouse;
- transferring information from the notebook to the desktop computer for more extensive periods of work;
- being aware of the importance of posture when using the notebook and frequently rotating between keying and other activities; and
- becoming keyboard literate to avoid periods of time looking down at the keys, which can contribute to neck discomfort.

The portable nature of these computers also means that they are frequently used where there is no suitable or adjustable workstation, for example, sitting the computer on the lap or on a kitchen table or using the computer in a cafe or motel. Prolonged use may contribute to discomfort.

Carrying laptop computers may also contribute to back and neck problems. The introduction of laptop computers to school children from an early age, and in some cases for some hours use per day, may mean that problems with portable computers may affect employees even before they enter the workplace.

## Electronic diaries or personal data assistants

These and other small electronic devices are normally used for short periods of time. Extended use of this type of keyboard is not recommended.

## Computer docking stations

Docking stations enable use of portable computers in a variety of locations without the need to continually transfer information to a desktop computer once at the office. The advantage of docking stations is the capacity to easily connect the portable computer to other peripheral devices, such as the screen and conventional size keyboard. This can improve the posture, actions and overall comfort of the user.

# OFFICE LAYOUT, WORKSTATIONS AND EQUIPMENT

---

## **Mobile phones**

Mobile phones are common for both office work and home use. Safety hazards, such as loss of concentration leading to accidents, arise when people try to perform additional activities at the same time as using a mobile phone, e.g. while driving. Noise in the office caused by ringing phones should be controlled by a policy of reducing volumes of phones in the workplace. There is some limited evidence on the risks from exposure to radiation sources and noise from mobile phones and it is recommended that mobile phone use is restricted and that phones are stored away from the body.

## **Voice recognition**

Voice recognition transfers voice information to an electronic format. This technology has limited application at present, but if the voice becomes one of the major means of entering and controlling computer data, then reliance on the keyboard for input will be reduced.

## **Software programs for OHS in the office**

There are a number of software products on the market aiming to improve safety in the office. For example, there are screen savers which prompt rest breaks or promote good working postures or exercises; programs for assessing or improving workstations; and various checklists and user surveys for assessing OHS in the office. A poorly designed program may interrupt work and raise the user's annoyance levels. It is important to trial these in your own organisation before purchasing to ensure they will meet your needs.

## **DIFFERENT TYPES OF OFFICE WORK**

Some office working environments may pose specific risks because of the type of work or the demands of work. Minimising risks in these environments depends on careful assessment of the effects on the people involved. Some examples are listed below.

### **Customer-controlled or 'call centre' work**

Many office jobs are in telephone call centres, often requiring long periods of time to be spent in a fixed posture. Other OHS issues include hearing problems, what is known as acoustic shock, vocal problems and stress from irate or difficult customers.

The design of call centre workstations and environments is the same in principle as for general office work, but special care must be taken with the design, provision and hygiene of essential equipment such as headsets. Easily adjustable furniture and equipment is important as employees have to move from workstation to workstation both within and between shifts. Given the constrained nature of the work, issues of job design must be carefully considered. These would include introducing some variety into the work, taking adequate breaks and 'time out' pauses for operators. See the *Good Practice Guide to Occupational Health and Safety in Call Centres*.

# OFFICE LAYOUT, WORKSTATIONS AND EQUIPMENT

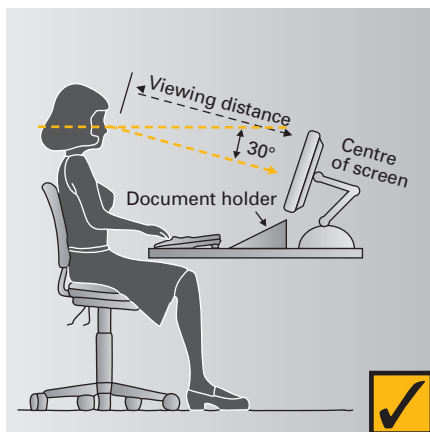

Figure 4.16 Location of a document holder and monitor at a workstation



Figure 4.17 Shelving too high and deep



Figure 4.18 Controlling risk of storage at height

## Home offices

Home-based work is being used increasingly by many large organisations. In addition, many small businesses operate from the home, setting up an office in a section of the house to run the business. A home office may not have the technology available of a large office, for example, a scanner or a photocopier, and repetitive manual work may be increased. Where people work at home, lack of social contact may lead to boredom, lack of motivation and loss of involvement in the decision-making within the organisation. Balance between work at home and contact at work in a larger office setting should be considered.

Some health and safety issues to consider when setting up a home office, include:

- the suitability of the range and duration of activities for this environment;
- the suitability of the design of the home office, including workplace layout, provision of furniture, equipment and separation from other areas of the home;
- the environment, e.g. lighting and thermal comfort;
- the selection, motivation and management of staff;
- training in safe working procedures; and
- involvement of the person in the planning and evaluation of work to provide them with control and feedback about their work and prevent isolation.

Policies and procedures should be developed to cover the occupational health and safety issues of working at home, including job design, hours of work, breaks and task variation. Further information on the psychosocial aspects of work are discussed in Section 2. Environmental issues are discussed in Section 3. General information about office workstation design and equipment is discussed elsewhere in this section.

## Off-site administrative or audit work

Intensive computer work can be required in circumstances such as reporting proceedings of conferences or corporate meetings, or during audits of organisations. These working environments may be poorly designed for the tasks with inappropriate furniture, lighting, noise and equipment. The work may be highly repetitive over a number of days. A policy should include provision by the host organisation of an appropriate workstation, equipment and environment or the employer should provide portable equipment, e.g. laptop stand, separate mouse and keyboard, and a trolley for equipment transport. Staff numbers should allow for regular breaks from intensive keyboard or mouse use or periods of high concentration. See Sections 2 and 3 and design issues in this section.

## Reception or counter areas

There are many office jobs which involve interaction with customers or clients. Where work involves a variety of users and tasks, including administrative and computing activities, adjustability is required to accommodate staff. Wider bench surfaces may be required for the placement of delivery items and to improve staff security, but care should be taken to avoid the need for reception or customer service staff to have extended periods of reaching up and forward. Security features, such as screens or emergency buttons, may be required.

The design of reception areas should reflect the type of work involved. Desks may need to be low to accommodate discussion and interviews, or high to separate staff from clients or customers. When the desk is high, thought needs to be given to whether staff need to be seated up high, possibly on a high adjustable chair with a footrest, or perhaps a false floor is required to raise the staff to the level of the customer (see Figure 4.1). The height should reflect the type of work and whether the worker is sitting, standing or both at the workstation. AS/NZS 4442 recommends the appropriate design of counter workstations. Work practices to allow variation in tasks and breaks from constrained posture and customer demands are important.

# OFFICE LAYOUT, WORKSTATIONS AND EQUIPMENT

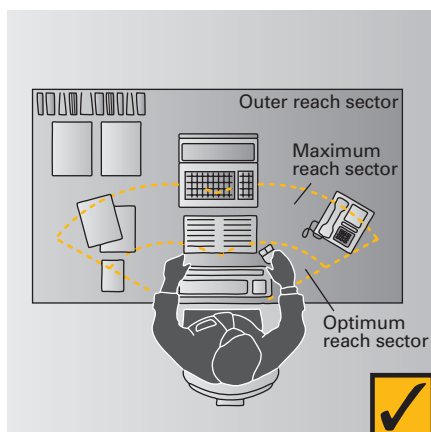

Figure 4.19 Reach sectors on a desk

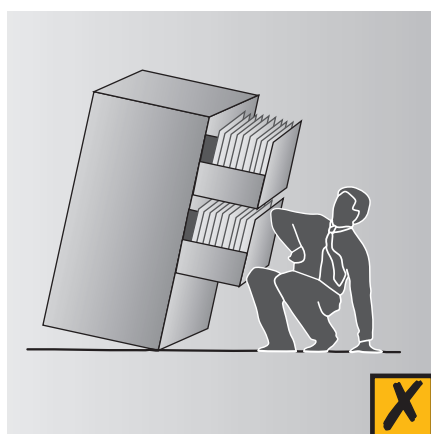

Figure 4.20 Filing cabinet may be unstable when fully loaded and the top two drawers are open

## STORAGE AND MOVING SYSTEMS

Storage system design should focus on the nature of items to be stored and the capabilities and limitations of the people required to use the system.

### Shelving systems

Users need to have clear access to shelving systems and the items stored on them. To achieve the required level of access, redesign or the provision of additional equipment will sometimes be required. For example, large shelving systems often have a top level of shelving that is above head height, or shelves may be too deep, requiring staff to bend and reach in. Redesign of the shelving and relocation of items between knuckle and shoulder height should be considered. If this is not practicable, some of the following controls should be considered:

- a safe means of climbing up to the required level; and
- an intermediate support point to enable lifting or lowering in stages as users step to higher levels.

Climbing shelves to access higher shelves is an unsafe practice and is a risk that requires control. Options for control of this risk may include providing small platforms on rollers (as often found in libraries), small sets of step ladders, platform ladders and rolling ladders. Steps should be stable and platforms and hand rails are required where the work includes access to high storage (see Figure 4.18).

If you have to climb to above 2 metres you must comply with the requirements of the *Victorian Occupational Health and Safety (Falls Regulations) 2003*.

### General principles of storage areas

- Large or heavy items should be stored at easily accessible heights to minimise the demands of handling. Frequently handled items should be placed within easy reach. Items carried on a trolley should remain on the trolley while in storage.
- Smaller, lightweight and infrequently handled items may be stored in the lower or higher areas of a storage system.
- It should be easy to place items into the storage unit and take them out.
- The storage system should accommodate the size and shape of the item being stored. For example, dividers will secure files stored in shelving and improve access to them. Documents or small publications may be stored in suspension files or folders, making them easier to handle.

### The desktop

As a storage system, the layout of equipment and resources on a desk should be arranged so that they are within reach. Their proximity to the user should be prioritised according to the nature or the item and how it is used.

### Reach capacity

The desktop can be broken up into three broad sectors according to the capacity of the seated individual to reach to each sector (see Figure 4.19).

The optimum reach sector is where the hands operate for most of the time. Equipment is usually brought into and out of this area as different tasks are performed. For example, when a typing task is finished, the keyboard is moved to one side to make room for a writing activity, or the chair is moved to a different part of the desk so the hands can function close to the body. Frequently used items, such as the keyboard, mouse or telephone, should be used in the optimum reach sector.

The maximum reach sector involves an area that extends beyond optimum reach where, using the shoulder and arm, the user can reach with comfort. This sector should be where the hands retrieve and deposit equipment and materials on an intermittent basis. Reference manuals are an example of what can be kept in the maximum forward reach zone, but not in a high reach zone, where excessive force may be required to lift them down.

# OFFICE LAYOUT, WORKSTATIONS AND EQUIPMENT

---

The outer reach sector involves extended reach where bending forward and even rising from the chair gains extra distance to reach an item. This area is usually only suitable for occasional reaches.

Where possible, layout should be reorganised to bring frequently used objects and nearby objects closer to the user. Alternatively, work can be relocated altogether to another desk or bench for better access. Locating rarely used items out of reach, requiring the user to get up from the chair, may encourage changes of posture.

## ***In/out trays***

These trays can usually be placed in the maximum reach zone and stacked on top of one another or placed side by side. Placing the trays closer to the operator helps improve posture and movements by limiting the need for extreme reaching.

## ***Drawers***

Mobile drawer units provide greater flexibility in the layout of a workstation to provide adequate space for the user's legs. Drawers need to be within comfortable reach and easy to use by moving the chair directly in front of them. Under desk drawers should not be used for the storage of heavy objects.

## ***Filing cabinets***

Some common problems and solutions with the use of filing cabinets include:

- tightly packed files – may contribute to muscle soreness and holding awkward postures. Clear labelling and periodic review of the contents can help overcome overcrowding. Other means of storage include arch files. Offsite storage can be used to reduce overcrowding;
- access to lower drawers – users should use their legs to squat or alternatively adopt a kneeling posture in preference to bending; and
- where a cabinet is not level, the drawers may be difficult to open or close or even remain in an open position when not in use. This can be hazardous. Small packing pieces can help to level the cabinet. Use a spirit level to make sure the filing cabinet is level.

Instability of a cabinet when more than one drawer is open at once can result in the whole cabinet falling onto the user. Prevention measures may involve attaching the filing cabinet to the wall or floor or purchasing filing cabinets which allow only one drawer to be open at a time (see Figure 4.20).

## **The computer**

Computers are another form of storage system within the office and are the main means of generating and manipulating reference information. Their use as a storage base may lead to a reduction in physical storage requirements in offices, as well as improved efficiency in finding, reading and obtaining data. Backing-up of data is an essential component of effective information storage, so that in the event of a problem or equipment failure, the information is not lost or corrupted.

## **Compactus or mobile storage**

The compactus is a very efficient way to use storage space. There are several issues associated with the use of this equipment.

### ***Opening and closing the compactus***

The size and placement of winding mechanisms or handles to open or close a compactus should not present a trapping hazard for hands. They are often designed to be used by one hand. Placing a second hand on the unit to help exert additional pushing or pulling force can result in it being caught in between the units. The compactus should not require significant force to operate the handle. Proper installation and regular maintenance of the unit should ensure ease of operation. For large sets of frequently used compactuses electric controls remove the need to exert force to open and shut the compactus.



# OFFICE LAYOUT, WORKSTATIONS AND EQUIPMENT

---

## **General hazards**

With a large compactus it may be possible for a person to become trapped between the shelves while it is being operated by others. Also, the raised platform or rails can create a tripping hazard as the individual moves into and out of the units. Consideration needs to be given to the operating and lock-out procedures, adequate lighting, signage and flooring.

## **Lockers**

Often lockers are used to store valuable equipment or materials. The location of each item in a locker should be decided according to the size and weight of the item and the frequency of its use.

## **Photocopying and printing paper**

Boxes of paper are often stacked on the floor in offices. They should be placed in a dedicated storage area close to the printer or photocopier. The size and weight of boxes may create a risk of injury from manual handling. Many suppliers now provide paper in boxes of 5 or 6 reams rather than 8 to 10 reams. This has reduced the risks from manual handling by reducing the weight and size of each box so that they can be handled closer to the body. Appropriate strategies to reduce risks from manual handling should be developed, e.g. raising the lower storage height above the ground to minimise bending; avoiding the handling of full boxes by removing individual reams from the box one at a time; or ordering smaller quantities of paper on a more frequent basis so that they can be stored on shelving with clear access.

## **Using a trolley to handle stored materials**

The use of a trolley to carry materials to and from a central storage area may be required to minimise the demands of this task. This should not just apply to large or heavy items but also to smaller items like files. When choosing a trolley an assessment should be made of the workplace requirements. These include the type of floor surface and what size and type of wheel is required, whether the trolley should be adjustable to allow for materials to be slid directly from the trolley to a shelf, how accessible the trolley is to get items into and out of, and whether there are large quantities of material to be shifted, requiring some form of motorised trolley.

Items such as photocopy paper can be stored on a trolley close to the photocopier. This minimises storage at ground level and as the trolley can be used for delivery double handling is minimised.

A waist height trolley can be placed in the delivery area so that couriers can place items directly on the trolley. The trolley can then be used to transport the items to the required area.

# OFFICE LAYOUT, WORKSTATIONS AND EQUIPMENT

## CHECKLIST – OFFICE LAYOUT, WORKSTATIONS AND EQUIPMENT

### Is the design of the office suitable for the functions and tasks required, including:

- Personal and shared space and walkways?
- Floor surfaces?
- Partitions?
- Storage space?

### Are the workstations designed to reduce risks from awkward postures and movements, including:

- Chairs?
- Desks and benches?
- Data input devices (keyboard, mouse)?

### Are the risks from use of other equipment controlled as far as practicable, including:

- Telephones/mobiles?
- Laptops and electronic diaries?
- Peripheral equipment (such as forearm rests, document holders, staplers, etc)?
- Software packages?

### Are the risks from specific types of work controlled as far as practicable, including:

- Call centre work (repetition, noise, voice use, fatigue and shift work)?
- Reception or counter work (such as awkward postures and movements, constrained postures, threats to security)?
- Home offices (unsuitable environment, workstation design and space, isolation)?

### Is storage designed to control risks from slips and trips and manual handling, including:

- Shelving and filing (inadequate space, too high or low, in walkways)?
- Inadequate desk space, lack of mobile trolleys?

# 5

## WORKING WITH COMPUTERS

Working with computers involves health and safety issues directly related to sitting in front of screens, which have potential physical, visual and psychological impacts on human beings. Good design of the computer, the environment, furniture and work practices will minimise the possible negative outcomes of computer use. The following section discusses health and safety issues relating to computer usage.

### **Screen type**

Conventional computer systems have used cathode ray tube (CRT) technology for the display. Thin film transistor (TFT) liquid crystal displays (LCDs) have become an increasingly popular technology. LCDs offer many advantages over CRTs, including:

- faster search times for text and reduced errors;
- greater postural variety during computer work;
- freedom from flicker and geometric image distortions at the screen edges;
- uniform screen brightness and substantially less glare;
- thinner and lighter displays which require a narrower work surface at the same screen to eye distance and are easier to reposition;
- considerably less energy use and heat emission;
- better screen privacy because they cannot be clearly viewed from acute side angles; and
- no VLF/ELF electromagnetic radiation emissions associated with the scanning electron beam required for a CRT.

# WORKING WITH COMPUTERS

---

## Eye strain

Reading without adequate light or reading small print over long periods of time can sometimes cause eye strain. It is generally believed that visual fatigue does not contribute to long-term deterioration of the ability to see, although eye strain can cause eye irritation, watering and reddening of the eye lids or blurred vision. Some computer operators may suffer headaches associated with eye strain, particularly if the head and neck muscles are held in a static position. However, these complaints are also described by people performing other close visual tasks. Looking away from the computer to a far spot, walking away from the screen and giving the eyes some exercise, such as blinking, can decrease the effects of long periods of concentrating on a screen. A dry air conditioned environment can contribute to eye discomfort.

People with pre-existing visual defects may be more likely to suffer eye strain from using screens than those with properly corrected vision. Current research does not indicate evidence of screen use causing cataracts or other permanent eye problems.

## Eyesight testing

The purpose of eye tests for computer users is to identify and correct pre-existing visual defects that may cause discomfort as a result of the visual concentration needed for many screen-based tasks. Some organisations have an agreement for vision testing for all computer users and others may provide a subsidy for prescription glasses.

See Comcare Australia's *Fact Sheet No 8 – September 1995 Visually Demanding Tasks and Guidelines for Eyesight Testing and Optical Correction for Visually Demanding Tasks*.

## Spectacle use and computers

Many middle-aged workers suffer difficulty with close work, known as presbyopia, and require spectacles for correction. Bifocals are designed to correct vision when looking down through the lower portion of the lens for close work. This may be suitable for reading a document, however, when reading information on a screen, computer users are generally looking horizontally over the section of the lens designed to correct their vision. Many users lean forward and tilt their chins up to look through the lower part of the lens. This unnatural posture is unsatisfactory and can result in neck discomfort.

In these circumstances, spectacles with full corrective or multifocal lenses should be used and working documents located between the screen and keyboard or alongside the screen to ensure the same focal distances for both. This reduces the likelihood of the operator adopting unnatural neck postures. Computer users concerned about their vision or spectacles should seek advice from their medical specialist.

## HEALTH EFFECTS

### Epilepsy

Approximately 0.5% of the population has epilepsy. Up to 3% of them (that is, 0.015% of the total population) may be sensitive to flickering lights or certain patterns. Children are more likely to be affected than adults in this way.

The screen refresh frequency of CRT screens and of fluorescent lights is generally higher than the flicker frequency associated with this condition, so instances of this issue in offices are generally rare. LCDs should not affect epilepsy sufferers as they do not flicker.

If a person with epilepsy is starting a job involving office work, consideration should be given to the many factors that may aggravate this condition. If there is concern regarding flickering of a screen or lighting, a medical specialist should be consulted.

### Radiation and computer screens

Computer screens based on CRT technology are designed to emit visible radiation (light) with a brightness that is adjustable by the operator. In creating the display, small amounts of other types of electromagnetic radiation (EMR) are also generated at extremely low frequencies, including radio waves, infrared (heat), ultraviolet and X-rays. Other sources of EMR in general life include electric blankets, hair driers and other electrical appliances used daily. LCD screens only emit visual radiation.

Possible health effects of radiation include:

**Eye problems** – short-term visual discomfort may occur, but research so far does not indicate evidence of any permanent eye problems.

**Skin disorders** – ultraviolet radiation emissions from CRTs are extremely low and are not considered likely to cause skin disorders.

**Cancer** – although concerns have been raised that radiation from computers can cause cancer, research has failed to establish any causal link.

### Adverse pregnancy outcomes

There have been allegations of reproductive problems associated with working with computers. Reliable epidemiological studies conclude that the incidence of adverse pregnancy outcomes among computer operators is not significantly different from women who do not work with computers, so there is no firm evidence to support these allegations. Generally, exposure levels of computer operators to any radiation emissions are no different to those of other people in the community, since CRTs emit such low levels and LCDs do not emit radiation. There is currently no evidence of risk to either male or female reproductive systems. However, some organisations have a policy of allowing pregnant women to minimise exposure to monitors during their pregnancy.

# WORKING WITH COMPUTERS

## Prevention of radiation emissions

There are no Australian Standards or limits set for radiation exposure. The so-called 'Swedish limits' for computers, designed for measurement and testing of physical emissions, are sometimes used as voluntary recommendations to encourage manufacturers to produce monitors with extremely low emissions. Studies have so far shown only very low to insignificant levels of various radiation emissions.

So-called radiation filters for screens are unnecessary and may degrade the screen image. The best protection operators have from electric field emissions is the screen. It is therefore best that operators are located in front of the screen. The emission of electromagnetic radiation is mainly from the back of the unit and the cabling rather than from the screen. Although this level is low, it is prudent to further minimise any potential risk by ensuring that cables are housed and shielded where possible and personnel are not located closer to the sides or rear of any computer monitor than to the screen of their own unit. Organisations should continue to review information as it becomes available.

Users who remain concerned about the small emission of radiation from conventional screens may prefer to use LCDs.

Laptop users should be advised against the long-term use of the computer on their lap because of possible thermal effects.

In summary, there are claims that the low radiation emissions from CRT screens cause adverse health effects in operators. These claims are not supported by scientific research findings or reliable epidemiological studies at this time. On current evidence, the emissions are considered to pose minimal risk to the health and safety of computer operators.

## Guidelines for computer users

Guidelines and policies exist aimed at reducing musculoskeletal disorders (previously referred to as OOS or RSI (see Section 2)), and improving the content of work and the work environment. Some of these are incorporated in legislation regarding manual handling, others are developed by employer and employee associations for specific types of work, e.g. call centres. Several Australian Standards refer to the design of furniture, equipment and environments for office work. Where relevant, aspects of these guidelines have been incorporated into this guide and have been listed in the reference material for the section (see Appendix D).

### CHECKLIST– WORKING WITH COMPUTERS

- Is the furniture, equipment and environment designed to minimise risks from working with computers (lighting, workstation design, keyboard/mouse design)?
- Do the computer, screen type and position and cables minimise exposure to any radiation sources?
- Are employees provided with information about visual demands and radiation sources from screen-based work?
- Are employees informed about or given access to eyesight testing and prescription of relevant visual assistance for computer viewing where needed?

# 6

## GENERAL HEALTH AND SAFETY ISSUES IN THE OFFICE

This section provides information on some specific health and safety issues in offices, as well as hazards associated with office equipment, substances and housekeeping.

### **SPECIFIC HEALTH AND SAFETY ISSUES**

Specific policies can be developed and implemented for many workplace health and safety issues, including:

- smoking in the workplace;
- management of blood-borne diseases;
- drugs and alcohol;
- injuries and first aid at work;
- fire and bomb threat emergencies;
- personal assault, harassment and bullying; and
- early intervention and occupational rehabilitation.

These policies and procedures should be developed to meet the potential issues in the particular workplace, not developed reactively following an incident.

#### **Smoking in the workplace**

Environmental tobacco smoke is an airborne contaminant. Passive smoking may constitute a risk to health. Employers have a duty under the Act to provide and maintain so far as is reasonably practicable a working environment that is safe and without risk to health. Smoking is not permitted in Victorian workplaces.

To maintain a smoke-free workplace, a policy and a plan should be in place. Some organisations provide education programs and assistance for those wishing to quit smoking.

# GENERAL HEALTH AND SAFETY ISSUES IN THE OFFICE

---

## Transmissible diseases

A policy for minimising the risk of transmission of blood-borne diseases such as hepatitis B and C and HIV will assist employers and employees to manage the issues associated with the prevention and management of these hazards.

Most people in offices are not exposed to the risk of transmission of hepatitis, HIV or AIDS from work although this risk is increased in health and human service organisations. Increased risk may occur if the office worker is exposed to infected blood, body tissues or fluids. An example of this is during first aid procedures. A policy on blood-borne diseases should provide guidelines for dealing with situations where there is an increased risk of transmission. Specific issues regarding freedom from discrimination and the confidential treatment of employees with infections need to be incorporated within the policy. Guidance can be found in the *National Code of Practice for the Control of Work Related Exposure to Hepatitis and HIV (blood-borne) Viruses (NOHSC: 2003)*.

## Drugs and alcohol

Alcohol and drugs can interfere with a person's performance at work. The effects of drugs and alcohol in the workplace include deterioration in productivity, quality of work, motivation and working relationships.

A policy on the management of drugs and alcohol in the workplace can help ensure the health and safety of employees, minimise the cost of absences and prevent productivity problems, improve working relationships and provide assistance to employees when required.

## Injuries in the office and first aid

Musculoskeletal disorders, cuts and bruises are the most common injuries occurring in the offices. Legislation requires employers to provide adequate facilities for the welfare of employees in the workplace. This usually includes appropriate first aid facilities and suitably trained persons. Policies and procedures for first aid in offices should ensure the implementation of an effective approach to the management of injuries. The WorkSafe publication *First Aid in the Workplace (Code of Practice No. 18 1995)* provides guidance for establishing procedures for dealing with minor injuries and illness at work. Figure 6.1 outlines the assessment of first aid provision needs for an organisation.

## Early intervention and occupational rehabilitation

The emphasis of workplace-based early intervention and rehabilitation is to maintain injured employees at work or return them to appropriate work in a timely and cost-efficient manner. This requires workplace procedures and the designation of responsibilities. Advice should be sought from the appropriate workers' compensation authority or insurer.

A policy for early intervention and occupational rehabilitation should integrate with relevant occupational health and safety prevention policies and procedures to ensure that the risks associated with workplace injury are managed effectively. Refer to NOHSC's *Guidance Note for Best Practice Rehabilitation Management of Occupational Injuries and Disease (NOHSC: 3021 (1995))*.

## Emergencies in the office

Generally, office emergencies are rare. However, an essential part of occupational health and safety is to be prepared for events such as fire, bomb threat and personal assault emergencies in case they occur. Some issues to consider during policy development include emergency evacuation procedures for staff and the public and arrangements with emergency services. Appointing, training and equipping floor wardens as coordinators between staff and these agencies can be a central step to handling emergencies well. Emergency evacuations should be practised at regular intervals to ensure procedures are known by all employees.



# GENERAL HEALTH AND SAFETY ISSUES IN THE OFFICE

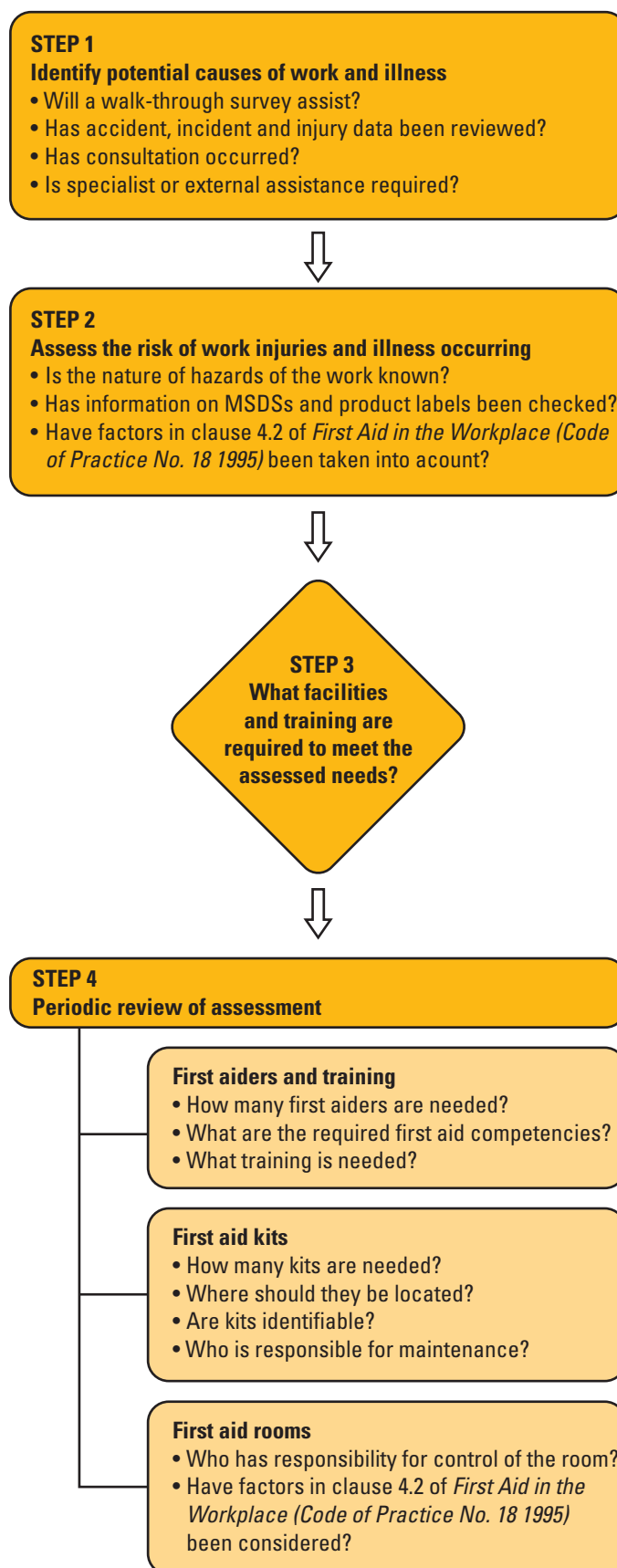

Figure 6.1 A process for assessing first aid facilities and training in the workplace (First Aid in the Workplace Code of Practice No. 18 1995).

# GENERAL HEALTH AND SAFETY ISSUES IN THE OFFICE

---

## EMERGENCY MANAGEMENT

### Security and emergencies

Every office has potential security and emergency situations, such as fire, bomb threats or forced entry or hold-ups. The risks from emergencies or security breakdowns will vary considerably depending on the size and layout of the office, the industry involved and the type of information and valuables which may be on the premises.

No matter how small, every office or workplace should have a fire protection system in place. This may range from a simple plan of exit and provision of fire extinguishers to a system of elected and trained fire wardens, a central controller and immediate communication to fire services. In addition, every employee should be aware of the hazards which may contribute to a fire, be aware of and have practised an emergency exit from the workplace at regular intervals.

Secure entrance to buildings and identification of employees is necessary for multi-storey and large offices, particularly where there is potential for client threat or violence or theft. Provision of duress alarms for staff facing the public and design of entrance areas to discourage client access are part of the prevention of breaches to security. In areas of particular threat security staff may be required to monitor entrances and vet visitors.

Wherever there is a possibility of threat of weapons or bombs, a documented telephone procedure should be available to all staff to guide them in responding to threats and getting information to identify the person making the threat. Emergency clearing of the building or area may be required and staff should be aware of the procedures for exiting the workplace, for example in the case of a fire.

For a complex working environment a consultant in emergency management may be required to set up systems to minimise risks from physical or psychological damage in emergencies.

### Managing violence and trauma

It is important that your office has a response plan for client aggression incidents if there is a likelihood of these occurring. Issues of prevention of risks from occupational violence are discussed in Section 2.

Following serious emergencies, trauma counselling may be required for exposed staff. Arrangements for this service should also be a part of a well developed emergency response plan.

Relevant publications for each of these health and safety issues can be found in Appendix D.

# GENERAL HEALTH AND SAFETY ISSUES IN THE OFFICE

---

## **COPYING AND SIMILAR EQUIPMENT**

Copying and printing machines are commonplace in offices. They include photocopiers, facsimile machines and laser printers. Despite their widespread use, these machines pose little risk to employees' health and safety under normal circumstances provided a few basic principles are followed.

### **Potential hazards**

Heat and light are produced during use of these machines. Some equipment may also result in the release of particles and gases into the environment. Awareness of these potential hazards and adherence to some simple principles and risk control measures will virtually eliminate any risk to health and safety from such equipment. Purchase of well-designed equipment will also assist in achieving this.

### **Common issues**

#### ***Exposure to light from the photocopier***

The lamp used in photocopiers produces a fairly intense light. This can affect what you can see for a short time, rather like a camera flash does. During normal operation, however, the thick glass plate between the lamp and the operator screens out any harmful light (such as ultraviolet rays). Nevertheless, continuous exposure to the bright light can lead to eye discomfort, even though damage is unlikely to occur.

#### ***Ventilation for multiple machines***

Often photocopiers, fax machines and printers are kept in one room. Adequate ventilation will ensure atmospheric contaminants do not build up to levels that may pose a risk to the health of employees around these machines. Normally, the door should be left open to assist air flow. If noise is a concern or the door is closed for other reasons, the effect on ventilation should be assessed and appropriate modifications made.

#### ***Toner dust***

The extremely low levels of impurities in toners are believed not to warrant concern for long-term health effects. Toner dust can enter the atmosphere during toner replacement or disposal of waste. If inhaled, the dust may irritate causing coughing and sneezing. A copy of the Material Safety Data Sheet (MSDS) from the manufacturer of the toner will provide the health and safety information needed to identify and assess the hazards. It will also provide handling and storage information.

#### ***Ozone***

Some photocopiers produce ozone, however, the concentration of ozone around copying equipment is insufficient to cause known adverse health effects.

#### ***Physical factors***

Possible discomfort from the light, heat and noise generated by copying equipment should be considered. Although exposure to the bright photocopier light has not been shown to cause eye damage, discomfort to operators or persons working in the vicinity is possible and should be prevented. It can also be distracting.

Unless ventilation is inadequate, heat from standard office copying equipment will have little effect on the office environment. Hot machine components, however, can pose a hazard to employees opening equipment to clear paper jams.

Office equipment should not produce hazardous noise levels but can cause annoyance and distraction to employees working in the vicinity. If noise from equipment is a concern, see Section 3.

Consideration should also be given to the physical comfort of employees operating copying equipment and possible risk of musculoskeletal injuries from repetitive sorting and collating with less efficient equipment. See Section 2 for more information.

# GENERAL HEALTH AND SAFETY ISSUES IN THE OFFICE

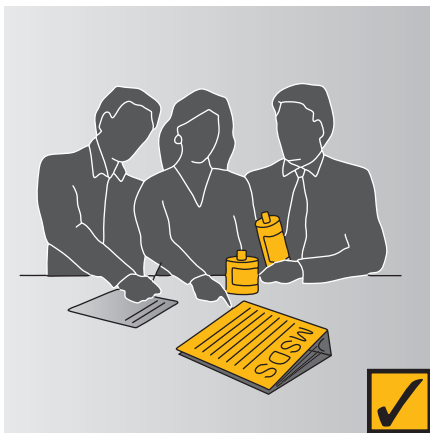

Figure 6.2 Obtain information about hazardous substances

## Tips and recommendations

The following recommendations are designed to help safeguard the health and safety of employees working with copying and similar office equipment.

1. When purchasing new equipment:
  - choose machines that recycle toner, use sealed toner cartridges and waste containers, filter exhaust air, and have automatic cut-off when the waste container is full or when the machine is opened;
  - purchase toner with specifications indicating minimal risks to health and safety;
  - consider the noise emission and where the machine is to be located;
  - equipment should have no exposed moving parts posing risk during normal operation; and
  - design must not allow contact with live electrical contacts for operators clearing paper jams.
2. Locate equipment in a well-ventilated area. Seek a location with the least disruption to surrounding employees. Machinery should not obstruct aisles or building exits. Ensure adequate space around the machine for operation and access for maintenance.
3. Install equipment in accordance with the manufacturer's specifications. Obtain appropriate operating diagrams, instruction manuals and MSDS and locate them near the equipment.
4. Specify personnel to carry out routine operations such as clearing paper jams and changing toner containers. Provide specific training to these employees and general appropriate training to all users of the equipment.
5. Procedures for safe use of the machine, together with the name of the person nominated as responsible for the machine, should be clearly displayed.
6. All copying and like machines should be regularly maintained to the manufacturer's specifications by authorised service personnel and a register kept of maintenance, repairs and replacements.
7. Consider the height and positioning of equipment and work surfaces to avoid operators sustaining awkward postures.
8. Always avoid looking directly at the light from photocopiers. Try and locate the equipment where it affects as few people as possible. The document cover should be closed wherever possible when photocopying.
9. Exercise appropriate safety precautions when clearing paper misfeeds. Beware of hot components and follow the manufacturer's instructions.
10. While spilled toner may not be hazardous, gloves should be readily available. Dispose of waste toner as recommended by the manufacturer.
11. Continuous photocopying and collating should be avoided. Schedule duties appropriately or allow for adequate breaks from such tasks.
12. Consider features such as automatic stapling, hole punching, collating and double sided printing to eliminate these manual tasks.

## HAZARDOUS SUBSTANCES

Some of the substances used in offices may be hazardous, however, these generally pose little risk under normal circumstances and conditions of use within the office environment. Examples of such substances include cleaning fluids, liquid paper, glues, inks, solvents and cleaning agents.

An up-to-date MSDS should be held for each substance used at the workplace (see Figure 24). Material Safety Data Sheets can be obtained from the supplier of the product. Guidance on what should be included in a good MSDS may be found in WorkSafe Australia's *National Code of Practice for the Preparation of Material Safety Data Sheets* 2nd edition (2003).

After doing a survey of materials being used in the office and obtaining MSDSs from the suppliers, copies of these should be assembled at one or more accessible points as a register. For example, they could be kept in a ring binder in the tea room or photocopier room.

An assessment of exposure should be conducted for each hazardous substance used in the office.

# GENERAL HEALTH AND SAFETY ISSUES IN THE OFFICE



Figure 6.3 Electrical and trip hazards

## HOUSEKEEPING ISSUES IN THE OFFICE

It is easy to overlook housekeeping in a busy office environment. Good housekeeping practices protect people from a variety of possible injuries and illnesses, including injuries from manual handling, electrical and tripping hazards and infections. Good housekeeping also provides a pleasant and clean workplace – and a safe one! Housekeeping extends beyond a consistent approach to office tidiness.

### Storage facilities

Storage facilities need to be maintained and reviewed periodically to ensure that they are functioning safely and are being used to their best advantage. They should be easily accessible to relevant staff and organised so that handling risk is minimised.

The storage of cleaning products is also important. Each product should be stored in an appropriate container and clearly labelled with the product name. It is easy to forget that common cleaning products can also be harmful chemical substances if an accident occurs.



Figure 6.4 Slips, trips and falls

### Waste paper

The collection, disposal and recycling of waste paper should be planned and maintained to minimise disruption and hazards in the office. The location and use of paper shredding machines should take into account the noise they generate and the mess from spillage when they are emptied. The placement of paper into a shredder can be hazardous if items of clothing such as ties become trapped. Shredders with an angled entry chute should be used.

### Food hygiene

Ensuring that food hygiene is maintained is important. Harmful bacteria can be transmitted through poorly cleaned eating utensils and unwashed dishcloths. Old food in the work fridge is not only smelly, it can introduce bacteria into the main food storage area. Develop a system for checking that unwanted food is thrown away at the end of the working week, and that adequate washing up facilities or a dishwasher are available.

### Electrical safety

Electrical extension cords on floors can be trip hazards. They are also easily damaged by trolleys and chair castors, and can then become an electrical hazard. The use of electric radiators in the confines of office workstations can be hazardous. Alternative appliances may be used on a temporary basis while the climate control in the office is under review, repair or maintenance, but these should be of a closed variety with no potential for causing a fire hazard.

Overloading power boards and using unauthorised or modified plugs can lead to electrocution or fire. Frayed power cords also increase the risk of these hazards.

A qualified electrician should be engaged to provide additional outlets if many power boards are used and to test and tag electrical equipment at appropriate intervals.

### Slips, trips and falls

Slip and trip hazards are a major source of office accidents and injuries. Slips often occur when a person walks on a slippery floor. This can be avoided by the prompt clean-up of spilled materials. Trips often result from obstructions and uneven surfaces and can usually be avoided by ensuring that floor surfaces are clear and even.

Falls are likely if chairs or shelves are used as steps to reach upper storage levels. Falls can also occur on poorly designed or badly lit stairwells or worn stair edges.

# GENERAL HEALTH AND SAFETY ISSUES IN THE OFFICE

---

## **Common problems**

### ***Inadequate storage facilities***

Storage facilities in most offices often reach their capacity. A system to review items held in storage is required. Old telephone books and redundant files can take up valuable space unless someone takes responsibility to dispose of them. Broken equipment should be repaired or replaced rapidly and not allowed to accumulate in valuable storage space. A labelling system can assist the management of storage. Off-site storage can be used as an alternative.

### ***Aisles clogged with cartons and trolleys***

Equipment and documents often move in and out of the office faster than people can deal with them. This can make the process of storing them awkward. It can be useful to set aside an area for items like cartons waiting to be packed or unpacked. This avoids the use of aisles and passages as a temporary storage space.

### ***Overuse of electrical extension cords***

As electrical equipment needs increase, it can be tempting to use extension cords to operate them. This can create problems as floors become cluttered with cables, which can trip unwary staff members. Electrical cords or cables should not be allowed to lie on floors because they are vulnerable to water and physical damage.

More power points should be installed in the office and cords and cables properly housed along walls or within partitions.

If extension cables are used, they should be linked to power boards with built-in safety fuses and switches for each outlet. Cords and cables can be temporarily taped onto door frames and pillars to get them off the floor, but permanent power points should be installed as soon as practicable.

## **Identifying hazards and assessing risks**

Identifying hazards is in the best interests of all staff. Since housekeeping covers a wide range of office activities and products, monitoring housekeeping can be a complex task. Checklists can help staff to be systematic in their approach to identifying hazards. A sample checklist can be found in Appendix A.

Staff reports on housekeeping problems are also a valuable source of information about areas needing attention and should be assessed regularly. Surveys of staff opinions and ideas can be useful for keeping information about the current housekeeping system and can be helpful in reviews.

Investigations of occupational health and safety incidents or accidents should consider whether housekeeping was a contributing factor.

## **Developing, implementing and evaluating solutions for risks and hazards**

It is better to develop regular practices for housekeeping than to assume that a large, irregular clean-up will protect your health and safety. Housekeeping is a problem best approached as a small regular task.

## **Relocating offices and moving furniture and equipment**

Relocation of office spaces can lead to OHS problems associated with manual handling of furniture and equipment. Often a poorly organised process can result in staff undertaking unusual and inappropriate handling tasks, such as lifting, carrying, pushing and pulling. Relocation requires a systems approach to the moving process. The following approaches are recommended:

- a move coordinator is appointed to organise a systematic, sequential process of relocation with allocated staff roles;
- a consultation process is undertaken with employees and Health and Safety Representatives to get staff input and ensure a cooperative effort;
- a hazard audit is performed to identify OHS issues in the move and allocate suitable control measures;
- the need for relevant moving personnel and/or equipment such as trolleys, ladders, boxes and protective equipment is assessed and organised;

# GENERAL HEALTH AND SAFETY ISSUES IN THE OFFICE

- staff are informed what manual handling they are not to undertake;
- adequate notice is given to staff regarding timing of removal and delivery of furniture to allow staff to plan and organise ahead; and
- staff are given guidance on preparing for the move, assessing risky handling situations, using relevant equipment, keeping access areas clear for moving of trolleys and equipment, asking for assistance from the coordinator or moving team, employing safe techniques and not lifting and carrying excessive or awkward loads.

Comcare's *Are You Relocating or Closing an Office?* (1998) has a comprehensive checklist for moving offices.

## CHECKLIST – GENERAL HEALTH AND SAFETY ISSUES IN THE OFFICE

- Are there policies in place to prevent smoking in the workplace?
- Is there a policy where necessary regarding drugs and alcohol in the workplace?
- Are the risks from copying equipment (such as light exposure, inhalation of fumes, heat) controlled as far as practicable?
- Are there documented procedures and regular practices for emergency management (such as fire, bomb threats)?
- Is there a system in place to manage the outcomes of traumatic events or violence in the workplace (such as a hold up, physical attack)?
- Is there adequate first aid equipment and trained first aiders?
- Is there a process of early intervention and rehabilitation following an injury?
- Has exposure to any hazardous substance been assessed?
- Are Material Safety Data Sheets provided in an accessible place for all hazardous substances?
- Is appropriate, lockable and marked storage available to prevent risks from hazardous substances or equipment?
- Are electrical cables undamaged and regularly tested and tagged?
- Are there appropriate closed systems of paper disposal?
- Are cleaning procedures adequate to manage risks from biological hazards (such as food, toilets)?
- Are floor surfaces kept clear, no worn areas and cleaned regularly to prevent slips and trips?
- Is appropriate equipment available for accessing high shelving (such as ladders with platforms, stools with friction brakes) to prevent falls?
- Is a risk assessment made when furniture or offices must be moved and are the risks from manual handling controlled as far as possible?

# APPENDICES

- A. Setting up your workstation
- B. Exercises for office workers
- C. Office safety checklist
- D. References and advice  
– where to obtain them

## APPENDIX A: SETTING UP YOUR WORKSTATION

Despite the availability and supply of adjustable workstation furniture and equipment, employees usually do not use these very well. The following checklist is a step-by-step approach designed to be used when employees are located at a new workstation or whenever their tasks change.

When setting up the position of this furniture and equipment it is important to try new positions to find the most comfortable arrangement for yourself. Give yourself a chance to get used to any changes, as it may take several hours or even days to determine the best position. Remember, it may take a few tries to get the best arrangement, but it is worth the effort – and if a change doesn't work, you can always reset it.

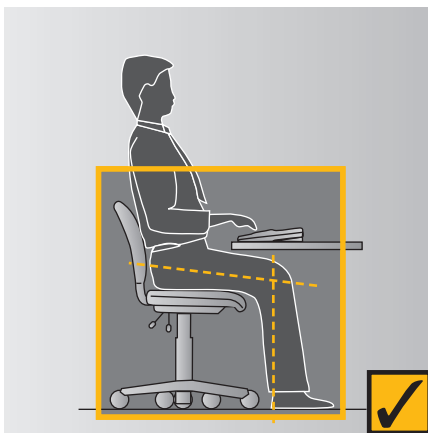

A.1

### Chair

When adjusting your chair please refer to any instructions that are provided with the chair or have someone show you how to adjust it and use the controls. If there is no one available to assist you, work through this checklist with another person and observe each other's postures and body positions.

Also, remember to try and avoid sitting for long periods of time. Some form of break from sitting every 20 – 30 minutes is helpful. Even getting up for 20 to 30 seconds to go to a printer or standing while talking on the telephone will provide some relief.

### Seat

*Height* – adjust chair height so feet are comfortably flat on the floor, thighs are approximately horizontal and the lower legs approximately vertical. Low heeled shoes will improve comfort of the legs with the chair at this height. See Figure A.1.

*Tilt* (if available) – set to horizontal or slightly forward to suit your comfort.

### Back support

*Height* – start by raising the backrest to its maximum height. Then sit in the chair and check the fit of the backrest to the curve of the lower back. If it's not comfortable, lower the height by several centimetres and try this position. See Figure A.2.

Repeat this adjustment and try each new position until the most comfortable fit is found. Ensure that the backrest supports the curve of your lower back and is not placed too low.

*Forward/backward position* – adjust the position of the backrest until a comfortable pressure is exerted on the lower back area while seated in the usual working posture at the desk. See Figure A.2.

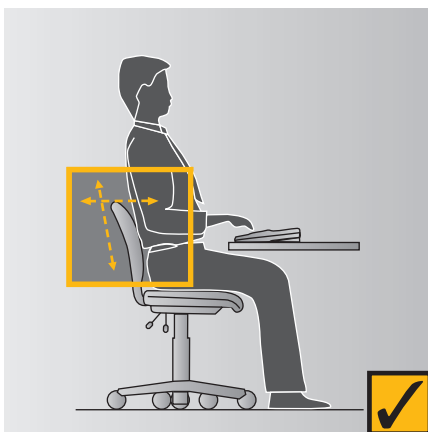

A.2



# APPENDIX A

## SETTING UP YOUR WORKSTATION



A.3

The backrest position should not feel as though it pushes you out of the seat or that you have to lean back too far to reach it. There should be a two-finger clearance between the front of the chair and the back of the knee. Trial a number of different positions until the best fit is achieved. A slight backward tilt is a preferred position as the force on the lower back is reduced. However, some people prefer to sit upright. You can vary this angle to provide changes in posture from time to time.

### **Armrests**

Armrests are usually not recommended unless they are short, fit under the desk or are adjustable. However, if your chair has armrests make sure that they do not prevent you from getting as close to the desk as you require (see Figure A.3) or that they impinge on your elbows while you are working. If this is the case, either remove them by unscrewing them, or replace them with a smaller or adjustable option. See Figure A.4.



A.4

### **Desk**

#### ***If you have a height-adjustable desk***

Having first adjusted your chair to suit your body size, adjust the desk so the top surface is just below elbow height. See Figure A.5. To determine your elbow height, relax your shoulders and bend your elbows to about 90 degrees and check the elbow height against the desk height. See Figure A.6.

#### ***If you don't have a height-adjustable desk***

If the chair has been adjusted and the desk is higher or lower than the elbow, other forms of adjustment will be required. Start by measuring the height difference between the desk and your elbow.

#### ***If the desk is too high***

Raise the chair by the measured difference and use a footrest. Set the footrest platform so that it is the same as the measured difference. See Figure A.7.

OR

Lower the desk by cutting the legs down by the measured difference. See Figure A.6.

#### ***If the desk is too low***

Raise the height of the desk by extending the leg length or sitting it on wooden blocks or something similar. Remember to ensure that any such changes are secure and stable.

### **Clearance under the desk**

General items, like computer hard disk drives, boxes of documents or files, rubbish bins and mobile drawers should not be stored under desks where they will decrease or interfere with the space required for the legs. This may force you to adopt a twisted or awkward posture of the spine. See Figures A.8 and A.9.

### **Drawers**

Most commonly used items should be placed in the top desk drawer to improve access and reduce reaching and bending movements. Where drawers are fitted to the desk, equipment such as the keyboard and computer screen should be arranged on the desk so that you can sit comfortably in the leg-well space.

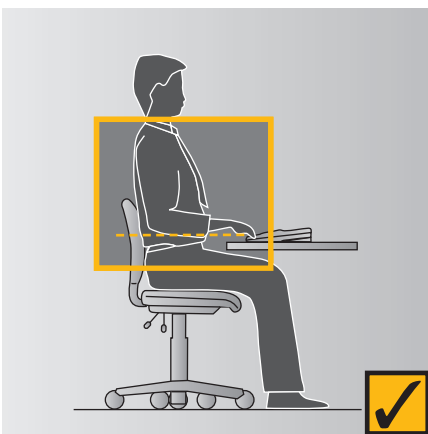

A.5

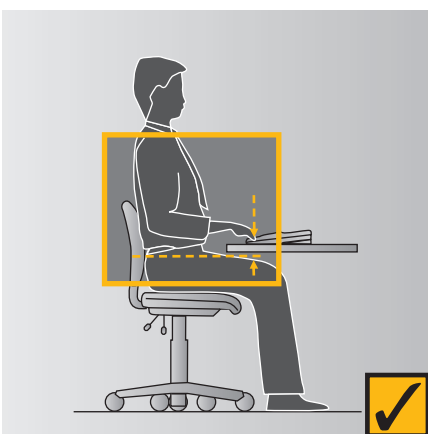

A.6

# APPENDIX A

## SETTING UP YOUR WORKSTATION

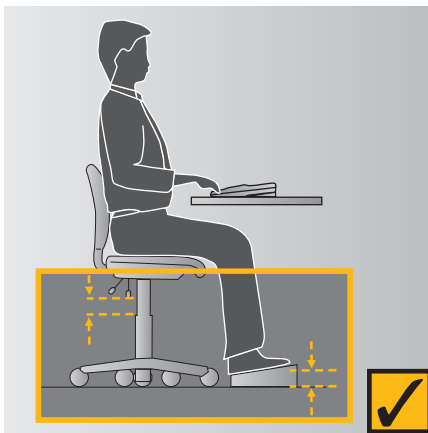

A.7

### General storage on the desk

#### In/out-trays

Place trays at the outer reach sector (see Figure A.10). In-trays should not be located above shoulder level.

#### Stationery

A variety of containers are available for mixed stationery items. These should also be stored at the outer reach sector (see Figure A.10) or in the top desk drawer.

#### Reference books and folders

Large or heavy references such as telephone directories and manuals should either be stored within close reach or in a nearby position where you need to stand to access them. Handling of these items should not be conducted at the limit of your reach capacity while sitting, as this can result in undue strain on the back, shoulder and arm muscles.



A.8

### Keyboard

#### Angle

Tilt the keyboard using the feet at the back to suit your level of comfort. The common and preferred setting is where the feet are lowered so the keyboard sits flat on the desk. This assists in preventing awkward postures of the wrists.

#### Position on the desk

Place the keyboard as close to the front edge of the desk as is comfortable (see Figure A.7). Do not place documents between the keyboard and the front edge of the desk while using the keyboard as this increases the reach distance to the keyboard and may result in excessive bending of the neck to look at the documents. Ensure that there is room to put the keyboard to one side when it is not in use.

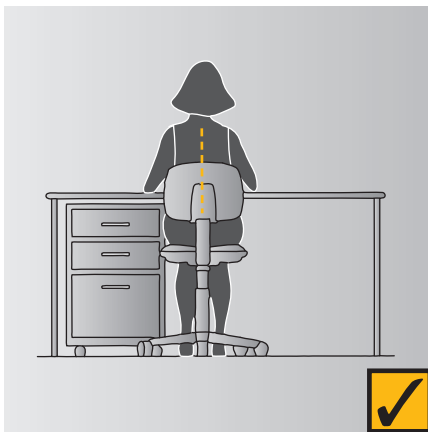

A.9

### Mouse

Place the mouse mat directly beside the end of the keyboard on your preferred side. Use the mouse in this position and always aim to keep the mouse on the mat during use.

If you frequently use the mouse in your work you may wish to:

- learn to use it with both hands so that you can swap between the right and left sides for improved comfort;
- set the tracking speed of the mouse to a setting that suits you;
- maintain your mouse to keep it in good working order (for example, keeping it clean inside); and
- where possible, try and avoid holding on to the mouse when not in use.

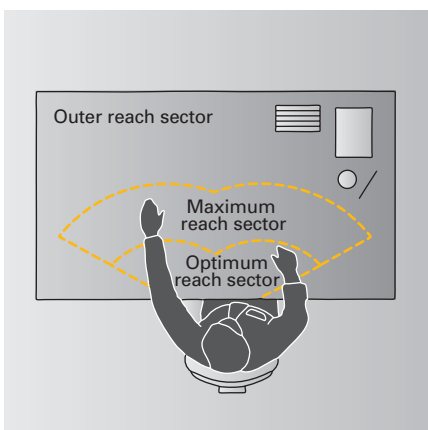

A.10



A.11

### Computer screen

The screen should be positioned once the chair and desk heights have been established.

#### Height

The screen should be positioned so that the top of the screen is level with, or slightly lower than, your eyes when you are sitting upright (see Figure A.11). If the screen does not have a raising device such as a monitor stand, you may be able to use telephone books to raise the screen height on a temporary basis.

#### Distance from the eye

First place the screen so that it is approximately an arm's length away from your usual seated position (see Figure A.11). Trial this position and if necessary move it further away or closer as required.

#### Positioning the screen

The screen should be placed so that it does not face windows, catching reflections from the windows, or have a window directly behind it causing glare from the window (see Figure A.15 and A.16).

### Document holder

The position of the document holder depends on your need to view and reach the documents and the type of document holder that is used.

For continuous or frequent data entry where the source document is observed more than, or the same amount as, the screen:

- place the screen slightly to one side so that the document holder is directly in front of the user (see Figure A.12);

OR

- place the document holder in a similar position to the screen where it is slightly to one side and you look evenly between the two (see Figure A.13).

An A-frame style book rest that sits on top of the desk is the most practical and can be set at different angles (see Figure A.14). It is usually best placed so that it supports documents on an inclined angle between the keyboard and the screen (see Figure A.12). For further information, see Section 4.

A lever or swivel arm document holder suspends the document above the desk at eye level. Anchor it to the desk on either the left or right or the screen, according to your preference, and place it directly beside the screen. See Section 4 for further information regarding document holders.

### Telephone

The telephone should be placed either within or at the limit of the optimum reach sector, depending on the amount of use (see Figure A.10). The placement should enable the user to operate the telephone without the need to move their trunk to grasp the handset or to operate the numeric and function buttons.

When making a lot of calls, it may be best to place the telephone on the same side as the dominant hand so that this hand can comfortably operate the numeric and function buttons. When mostly receiving calls, it may be more comfortable to place it on the non-dominant side.

Learn and utilise the functions of your phone, such as redial and the storage of commonly used phone numbers, to improve the efficiency of its use. Also, where the phone is used very often or for prolonged periods, a headset should be used.

### Angled reading and writing surface

An angled board can improve neck comfort where a job involves a lot of reading and handwriting. It should be placed immediately in front of the user on top of the desk (see Figures A.17 and 4.10).

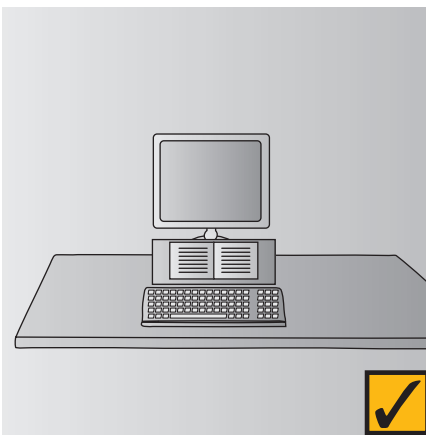

A.12



A.13



A.14

# APPENDIX A

## SETTING UP YOUR WORKSTATION

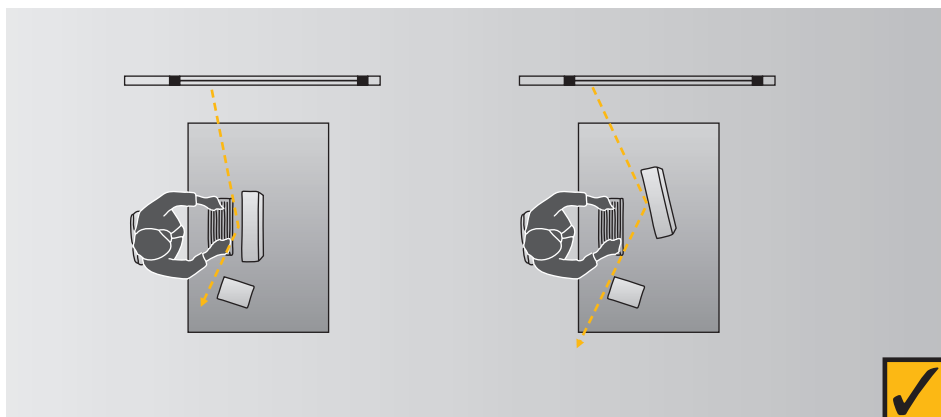

A.15 Placement of screen to reduce reflections

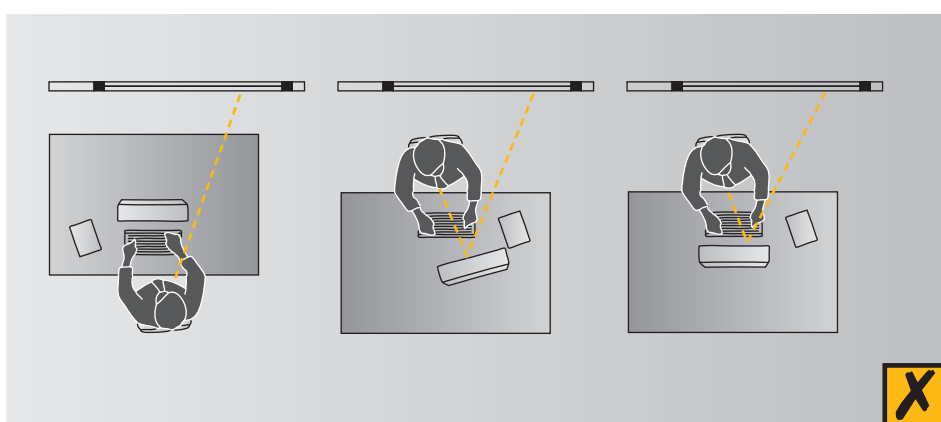

A.16 Screen position with undesirable reflections

### CHECKLIST

#### Setting up your workstation

##### Chair

Is the chair adjusted to fit you? Check that the:

- Backrest height and back tilt are adjusted to fit the curve of the user's back and allow a slightly reclined posture.
- Seat height and angle are adjusted so that user can sit with their feet flat on the floor, hips between 90 degrees and 120 degrees.
- An adjustable-height footrest is supplied if you need one.

Have you been shown how to adjust the chair to correctly support the body?

##### Desk/bench

Has the desk height been adjusted so the surface is set just below your elbow height?

If the desk is not adjustable, is the surface set just below your elbow height (e.g. chair raised slightly, foot rest supplied)?

# APPENDIX A

## SETTING UP YOUR WORKSTATION



A.17

### CHECKLIST CONTINUED

#### Desk/bench

Is the desk large enough to fit the task requirements of the job?

Is the desk deep enough to allow the computer screen to be approximately at arm's length away from you?

Is there adequate space under the desk to allow comfortable forward facing posture and ability to get in and out of the workstation?

Are the desk corners and under desk space rounded, smooth and free of sharp edges (e.g. no keyboard, shelves under desk)?

Are items such as disk drives, files, rubbish bins and desk drawers stored so that they do not interfere with available space under the desk?

Are frequently used items on the desk stored within easy reach (e.g. keyboard, telephone)?

Are large or heavy items stored within close reach and not above shoulder height, or nearby where you have to stand to access them?

Is there a sloped desk surface or angle board for reading and writing tasks if required?

For a standing desk, is the desk adjustable so the surface can be set just below the user's elbow height?

#### Computer

Is the keyboard close to the front edge of the desk allowing space for the wrists/forearms to rest on the desk surface (about 12 – 15cm)?

Are the keyboard feet adjusted to position the keyboard as flat as possible on the desk?

Have you been trained in touch typing to avoid the need to look down at the keys?

Is the mouse or pointer positioned as close to the keyboard as possible?

Have you been trained to operate the mouse as close as possible to the midline and not to hold the mouse when not in use?

Has the screen been positioned at approximately arm's length from your seated position?

Has the screen been positioned so you can look straight ahead and slightly down at the screen (top of screen level with or below eye level when the user is sitting upright)?

Has the screen been positioned directly in front of the user (or close this position if document holder or second screen required)?

Is there a document holder either beside the screen or between the screen and keyboard if required?

Is the screen positioned to avoid reflections or glare from windows or lights (e.g. not facing or backing onto windows)?

#### Telephone

Is the telephone placed within the close reach sector on the side which is comfortable to use with other tasks and equipment?

If there is considerable telephone work, is there a headset provided?

Is the headset appropriate for the task (one or both ears) and comfortable to wear?

Is the workstation appropriately positioned or partitioned to prevent interference noise?

# APPENDIX B

## EXERCISES FOR OFFICE WORKERS

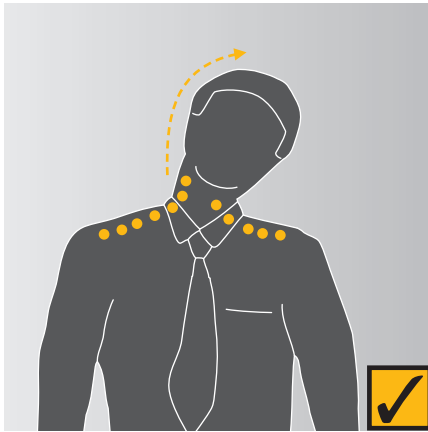

B.1 Neck stretch

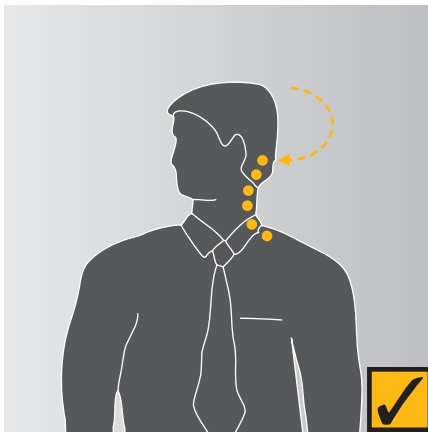

B.2 Head turns

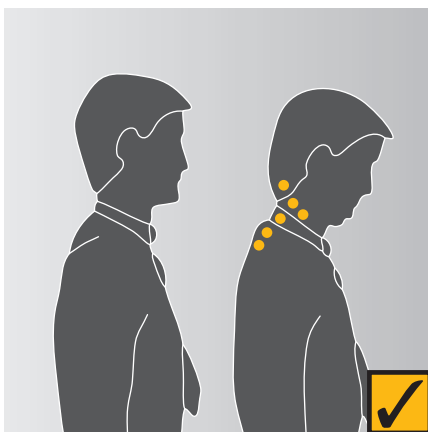

B.3 Chin tucks

### APPENDIX B: EXERCISES FOR OFFICE WORKERS

#### Stop, get up and move

Getting up and walking around is the best exercise you can get to provide a break from sitting, concentrating and using the muscles of the arms and hands. About every 20 to 30 minutes is a guide to how often it is helpful to move around.

Even getting up for 20 to 30 seconds to pick up papers from the photocopier or get some water is a way to change your posture and give muscles a chance to recover.

#### S-t-r-e-t-c-h and check!

Stretching exercises help to relax muscles which have been working and move those which have been in a fixed position. If possible, stand up to do your stretches.

While you are exercising, read the notes alongside each instruction and consider whether your workstation is adjusted to suit you. Refer to Section 2 for information on job design.

- Do a few of these exercises a few times every day.
- Dots show the muscles that you are exercising.
- Make sure you relax and perform them gently.
- Hold the stretch or repeat as indicated on the diagram.
- Do not over-stretch.
- Stop if you feel discomfort when performing an action.
- Remember to do each side.

#### Neck

##### Neck stretch

Keeping your chin tucked in, gently lower ear to shoulder and hold for 10 seconds on either side. Repeat several times. See Figure B.1.

##### Head turns

Turn head slowly to look over left shoulder. Turn head the other way. Repeat several times. See Figure B.2.

##### Chin tucks

Raise the head to straighten the neck. Tuck the chin in and upwards creating a double chin. This also results in a forward tilt of the head. Repeat several times. See Figure B.3.

##### Check neck posture

- Position the top of your screen at eye level.
- Use a document holder directly beside or below the screen – it saves you looking down.

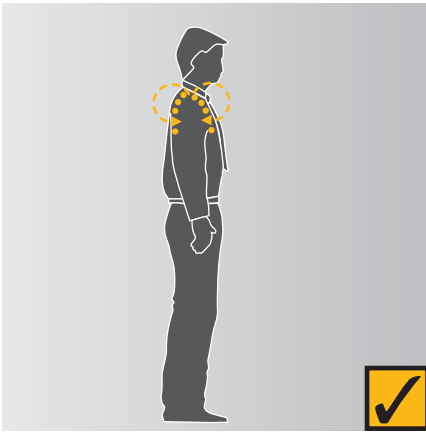

B.4 Shoulder rolls

### Shoulders

#### **Shoulder rolls**

Circle shoulders forward several times, then backwards. Repeat 3 to 5 times. See Figure B.4.

#### **Check shoulder posture**

- Relax your shoulders and rest your hands on your lap. Bend your elbows to no more than 90 degrees and check the height of your finger tips against your current work height. If the work (keyboard or desk) is higher than your hands you may be hunching your shoulders unnecessarily. If so, try and raise your chair height or lower your desk height and try and relax your shoulders while working.

### Wrists, hands and arms

#### **Wrist and elbow stretch**

Interlace fingers, palms outward, and straighten arms in front. Hold for 10 seconds and repeat several times. See Figure B.5.



B.5 Wrist and elbow stretch

#### **Wrist stretch**

Straighten your arm in front and bend your wrist forward, gently assist the stretch with your other hand. Hold for 10 seconds then stretch your wrist back and hold for 10 seconds. Repeat with other arm. See Figure B.6.

#### **Check hand and wrist posture**

- While keying, keep your wrist straight while your fingers are suspended over the keyboard.
- Keep elbows at keyboard level. This may mean adjusting the desk or chair height.
- Don't rest your wrists on the desk or keyboard while keying. Keep hands suspended.
- Rest on the desk between periods of keying.



B.6 Wrist stretch

# APPENDIX B

## EXERCISES FOR OFFICE WORKERS

---

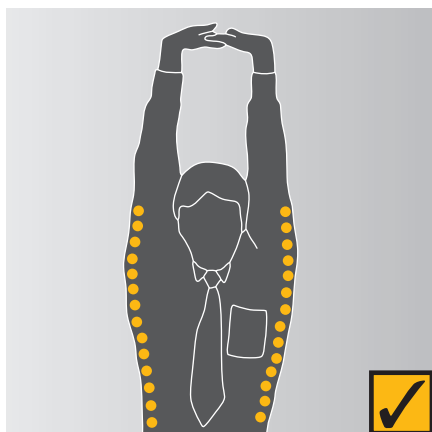

B.7 Upper and lower back stretch

### Upper and lower back

#### **Upper and lower back stretch**

Interlace fingers and turn palms upwards above head; straighten arms then slowly lean slightly from side to side. Repeat movement several times. See Figure B.7.

#### **Back arching**

Stand up. Support your lower back with hands and gently arch back and hold for 5 to 10 seconds. Repeat as often as is needed. See Figure B.8.

#### **Pectoral stretch**

Raise both arms to shoulder height and bend elbows. Pull both elbows back slowly to bring shoulder blades towards each other.

Repeat several times. See Figure B.9.

#### **Check back support**

- Sit well back in your chair – if your feet need support, use a footrest.
- Adjust the backrest on your chair to support your lower back.



B.8 Back arching



B.9 Pectoral stretch



# APPENDIX B

## EXERCISES FOR OFFICE WORKERS

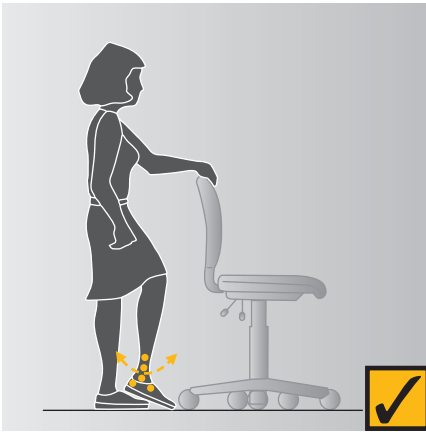

B.10 Foot pump

### Legs

#### Foot pump

Stand up, holding the chair for balance if necessary, and alternately raise heels and toes. Repeat 10 times. See Figure B.10.

#### Check leg comfort

- If the seat of your chair is digging into the backs of your thighs check that it is not too high or whether it is tilted backwards.
- If the seat is too high, lower the chair and desk or use a foot rest to support your feet.
- Also check the tilt of the seat and, if necessary, adjust it to a horizontal position.

### Eyes

#### Eye exercise

Sit up straight, face forward and repeat this sequence several times without moving your head. Look up, then down. Look left, then right. See Figure B.11.

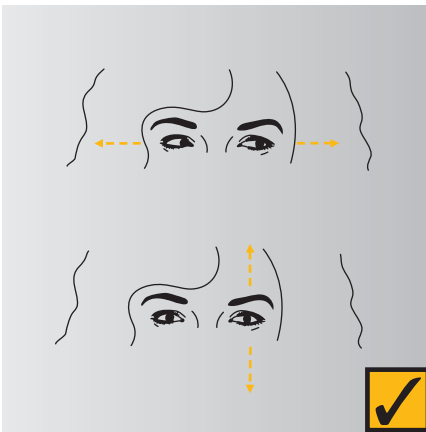

B.11 Eye exercise

#### Visual rest

Look up and away from the screen. Focus on a distant object (more than 3 metres away). For example, look out of the window or at a picture on a far wall. Shift vision back to screen and refocus. See Figure B.12.

#### Check eye comfort

- Is there enough light falling on your documents?
- Do windows or light fittings cause glare or reflection on the screen? If so, try turning the screen or blocking the path of the light.
- Use a screen with a light background when working with text. Software with a light background for text is more comfortable for the eyes.

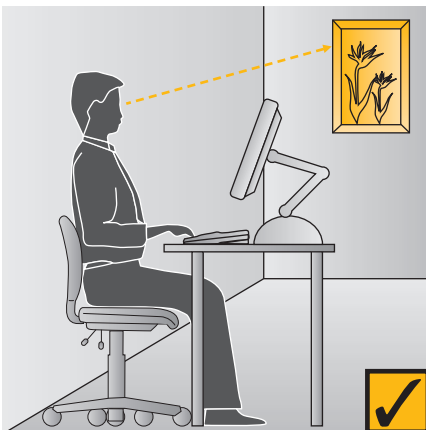

B.12 Visual rest

# APPENDIX C OFFICE SAFETY CHECKLIST



<b>Office:</b>
----------------

<b>Location:</b>	<b>Date:</b>
------------------	--------------

**Persons doing assessment:**

<b>Work area management rep:</b>	<b>H&amp;S or deputy rep:</b>
----------------------------------	-------------------------------

<b>Others (employees, consultants)</b>
--

This Checklist is designed to help employers identify existing or potential health and safety issues and meet their legal responsibilities in relation to health and safety in offices.

**How to use this worksheet**

Follow the worksheet step by step and refer to the guidance provided after each issue on the worksheet to:

- assess any occupational health and safety (OHS) issues associated with your office; and
- implement solutions to OHS issues and control any risks to the health and safety of employees.

**Consult with the relevant Health and Safety Representatives (HSR) and where possible involve the employees who do the tasks when assessing the tasks and planning and introducing risk controls.**

Arrange for regular workplace inspections and pay particular attention to:

Office layout
Workstations
Job design
Workload and tasks
Lighting
Manual handling
Noise
Indoor air quality
Radiation
Storage, housekeeping, cleanliness and cleaning methods
Floors and stairs
Computers, copying and other equipment
Hazardous substances
Personal protective equipment

**Keep a copy for your records**

You should retain your risk assessment if it shows a risk to employees.

**Fix the problems and control any risks**

This worksheet provides general guidelines only. It is important to control any risk you find, so far as is reasonably practicable.

## JOB DESIGN

REFER PAGE 12 OF OFFICEWISE

### Examples of issues which may affect health and safety, productivity and job satisfaction:

- Highly repetitive physical tasks (such as keying) performed for periods of 2 hours or more at a time without significant break.
- Tasks requiring sitting or standing for periods of 2 hours or more at a time.
- Tasks requiring high level of concentration for periods of 2 hours or more at a time.
- Excessive workload leading to long hours or taking work home.
- Employees having no or limited choice of when, how and how frequently they perform some tasks or this is determined by the equipment or machine they use or by their supervisor.
- Employees not trained to or able to vary tasks and postures throughout the day.

ISSUE TICK YES IF THIS ISSUE IS PRESENT	YES	RECOMMENDED SOLUTION	PERSON RESPONSIBLE TO IMPLEMENT SOLUTION	DATE FOR COMPLETION
Highly repetitive tasks (such as keying) performed for periods of 2 hours or more at a time	<input type="checkbox"/>			
Tasks requiring constant sitting or standing for periods of 2 hours or more at a time	<input type="checkbox"/>			
Tasks requiring high level of concentration performed for periods of 2 hours or more at a time	<input type="checkbox"/>			
Individuals unable to participate in decisions about their work and choose when, how and how often they perform most of their tasks	<input type="checkbox"/>			
Employees not trained or allowed to vary tasks and postures throughout the day	<input type="checkbox"/>			
Individuals not given feedback regarding their work performance	<input type="checkbox"/>			
Long hours of work, taking work home	<input type="checkbox"/>			
<b>Comments (i.e. when and where it is happening)</b>				

## POSSIBLE SOLUTIONS

- Intersperse highly repetitive tasks with other tasks requiring different movements and postures.
- Intersperse tasks requiring static or fixed postures with other tasks requiring more dynamic postures.
- Intersperse tasks requiring high levels of concentration with other less demanding tasks.
- Training provided on how to vary tasks and postures throughout the day.
- Supervisors ensure that employees vary their tasks and postures throughout the day.

# APPENDIX C OFFICE SAFETY CHECKLIST



## SOCIAL AND PSYCHOSOCIAL ISSUES

REFER PAGE 13 OF OFFICEWISE

### Examples of issues which may affect health and safety, productivity and job satisfaction:

- Employees not given training to perform their work.
- Lack of consultation on changes in the content, hours, location of the job.
- Client-focused or emotionally demanding work without opportunity to discuss.
- Bullying behaviours in the workplace.
- Potential violence from customers or intruders.
- Prolonged periods of night shifts or unsocial patterns.
- Inconsistent management processes or discrimination.

ISSUE TICK YES IF THIS ISSUE IS PRESENT	YES	RECOMMENDED SOLUTION	PERSON RESPONSIBLE TO IMPLEMENT SOLUTION	DATE FOR COMPLETION
No or inadequate training for new employees	<input type="checkbox"/>			
Employees not consulted on changes to their work content, hours and location	<input type="checkbox"/>			
No support or feedback system of employees dealing with difficult or demanding customers	<input type="checkbox"/>			
Bullying (harassment, intimidation, exclusion, withholding information) occurs with some employees	<input type="checkbox"/>			
Employees are placed in potentially risky situations without adequate supports (handling cash, working alone or at night, working with potentially violent clients)	<input type="checkbox"/>			
Discrimination against particular individuals or groups of employees	<input type="checkbox"/>			

### Comments (i.e. when and where it is happening)

## POSSIBLE SOLUTIONS

- Documented training for all new employees.
- Consultation processes for employees, e.g. regular staff meetings and processes.
- Policy and procedures on prevention and management of bullying, harassment and occupational violence.
- Policy, procedures and communication devices for prevention and management of potentially violent situations.

## MANUAL HANDLING

REFER PAGE 12 OF OFFICEWISE

### Examples of issues which may affect health and safety, productivity and job satisfaction:

- Lifting or carrying large, heavy or awkward office equipment, files or items.
- Repeatedly lifting, carrying, pushing or pulling items for more than 30 minutes at a time or more than two hours in the day.
- Storing often handled items below mid-thigh height or above shoulder height leading to risks from bending, twisting and reaching.
- Pushing heavy trolleys on high resistance surfaces or steep ramps.
- Tasks such as keying or hand stapling performed repetitively for more than 30 minutes at a time or more than two hours in the day.

ISSUE TICK YES IF THIS ISSUE IS PRESENT	YES	RECOMMENDED SOLUTION	PERSON RESPONSIBLE TO IMPLEMENT SOLUTION	DATE FOR COMPLETION
Large, awkward or heavy items handled manually	<input type="checkbox"/>			
Repetitive handling tasks over 30 minutes or for two hours over the day	<input type="checkbox"/>			
Handling items for a long duration	<input type="checkbox"/>			
Heavy trolleys used on resistant surface or ramps	<input type="checkbox"/>			
Repeatedly handling items outside preferred (mid-thigh to shoulder) working zone	<input type="checkbox"/>			

### Comments (i.e. when and where it is happening)

## POSSIBLE SOLUTIONS

- Use powered mechanical aids to handle large, bulky or awkward items or if not reasonably practicable, use an ergonomically designed trolley.
- Use lifts where possible for moving loads, or if not reasonably practicable, use ramps or use suitable trolleys on stairs. Loads should not be carried by hand on stairs. If this is not possible, ensure the load is small and light enough to carry in one hand to the side of the body.
- Relocate frequently used items to within the preferred working zone.
- Use powered office equipment such as staplers, hole punchers or binders to reduce the highforce actions sometimes required to operate manual equipment.
- Design rest or work breaks into the tasks to allow for muscles that have been working to rest and recover.
- Set up workstations to prevent awkward postures.
- Move and stretch at regular intervals.

# APPENDIX C OFFICE SAFETY CHECKLIST



## ENVIRONMENTAL FACTORS

REFER PAGE 22 OF OFFICEWISE

### Examples of issues which may affect health and safety, productivity and job satisfaction:

- Poorly lit work areas and walk ways; sudden changes in lighting levels occur between areas, i.e. between outdoors and a dimly lit stairwell, or between outdoors and loading bay; lighting that is badly directed; lighting throwing distracting shadows on steps, stairs, walking surfaces, etc; lighting that can make it difficult to see for the pedestrians or mobile equipment operators.
- Employees not able to control incoming natural light; artificial lighting causing reflections from work surfaces or shadows over the task; not enough light for the tasks; employees report tired, sore or irritated eyes.
- Difficult to hear a normal voice within a 1 metre distance; distracting or disruptive noises in the area; screens or partitions do not control noise.
- Staff suffer from dry, irritated eyes at the end of the day; office is stuffy; staff find the temperature cold, hot or fluctuating.
- Radiation emissions from old CRT monitors not tested within the last 12 months; staff located closer than 1 metre from a CRT monitor in any direction; no policies and procedures for the placement and size of CRT monitors; staff located near multiple electrical cords or computer cables; electrical and computer cables unoused or entwined near staff.
- Working in very cold or hot conditions.

ISSUE TICK YES IF THIS ISSUE IS PRESENT	YES	RECOMMENDED SOLUTION	PERSON RESPONSIBLE TO IMPLEMENT SOLUTION	DATE FOR COMPLETION
Insufficient lighting for task or security	<input type="checkbox"/>			
Employees not able to control natural light or glare	<input type="checkbox"/>			
Artificial lighting causing reflections from work surfaces or shadows over the task	<input type="checkbox"/>			
Uncorrected visual problems in persons required to undertake visually demanding tasks	<input type="checkbox"/>			
Noise loud enough to make it difficult to hear a normal voice at 1 metre distance	<input type="checkbox"/>			
Distracting or disruptive noises present that affect the employees in the area	<input type="checkbox"/>			
Temperature too hot, too cold or fluctuating and affects the employees in the area	<input type="checkbox"/>			
Air flow too high and affects the employees in the area	<input type="checkbox"/>			
Air flow too low and affects the employees in the area	<input type="checkbox"/>			
Inadequate ventilation for photocopiers and other equipment	<input type="checkbox"/>			
Persons constantly working in close proximity to radiation sources i.e. rear of CRT monitors, microwaves etc.	<input type="checkbox"/>			
Other environmental factors	<input type="checkbox"/>			

**Comments (i.e. when and where it is happening)**

### POSSIBLE SOLUTIONS

- Use recommendations from AS1680.1 to choose appropriate lighting levels for tasks.
- Install blinds, curtains or shutters on windows to control external light sources.
- Improve office lighting by relocating or increasing lighting.
- Improve office lighting by replacing defective light sources; cleaning light sources; increasing the wattage of the light source; replacing light source with a more suitable type or colour.
- Provide graduated lighting between areas.
- Provide eyesight testing for employees engaged in visually demanding tasks.
- Direct lighting so that does it not throw distracting shadows on steps, stairs or other walking surfaces.
- Isolate persons or control the noise of items of plant or equipment.
- Increase the height, direction or sound absorbency screens or partitions to reduce distraction noise.
- Adjust the air flow in the office or redirect the air flow.
- Install extraction fans around photocopiers and other such equipment in frequent use.
- Redesign layout so that persons are not required to work in close proximity to possible radiation sources for long periods of time.
- Check that employees are not exposed to environmental factors that may affect their behaviour or performance, e.g. heat, cold, chemicals or electricity.

# APPENDIX C OFFICE SAFETY CHECKLIST



## OFFICE LAYOUT

REFER PAGE 32 OF OFFICEWISE

### Examples of issues which may affect health and safety, productivity and job satisfaction:

- Insufficient space for the equipment and the operator.
- Insufficient space for light, intermediate and busy foot traffic.
- Insufficient circulation space around each workstation.
- No separate area for photocopying.

ISSUE TICK YES IF THIS ISSUE IS PRESENT	YES	RECOMMENDED SOLUTION	PERSON RESPONSIBLE TO IMPLEMENT SOLUTION	DATE FOR COMPLETION
Inadequate space for tasks to be carried out	<input type="checkbox"/>			
Insufficient space for busy or intermediate foot traffic through an area	<input type="checkbox"/>			
Insufficient space for individual workstations	<input type="checkbox"/>			
No areas for tasks that require dedicated space, i.e. photocopying	<input type="checkbox"/>			
Inappropriate floor surfaces for the tasks (slippery, reflective, difficulties with pushing equipment)	<input type="checkbox"/>			

### Comments (i.e. when and where it is happening)

## POSSIBLE SOLUTIONS

- Relocate equipment and workstations to provide adequate space for the tasks being performed.
- Review the tasks being conducted and consider whether they need to be done in that office or in another location.
- Space for busy foot traffic must comply with the requirements of the Building Code of Australia.
- Ensure aisle widths of at least 1 metre in intermediate foot traffic areas.
- Allocate areas for tasks that require dedicated space and install appropriate workstations for those tasks.



## WORKSTATIONS

REFER PAGE 34 OF OFFICEWISE

### Examples of issues which may affect health and safety, productivity and job satisfaction:

- Insufficient space at the workstation for documents to be spread out within easy reach; no easy access to equipment such as a telephone and keyboard; no height adjustability of work surfaces; workstations and equipment not set up to reduce awkward postures.
- Standing workstations not suitable for all users; insufficient width and depth for the tasks being carried out; no provision for sitting at this workstation when short periods of continuous work are required.
- Reception desks or counters too deep or high, inadequate work space or risk to security of staff.
- Chairs unstable when sitting down or standing up; chairs not adjustable for different users; chairs damaged or uncomfortable.
- No footrests provided for office workers who cannot rest their feet flat on the floor when their chair is adjusted to suit the desk height.
- No suitable document holders available should user require one.
- Staff not trained to adjust workstation and chair.
- Frequent telephone tasks without headsets.

ISSUE TICK YES IF THIS ISSUE IS PRESENT	YES	RECOMMENDED SOLUTION	PERSON RESPONSIBLE TO IMPLEMENT SOLUTION	DATE FOR COMPLETION
Seated workstations not designed for suitability for tasks done	<input type="checkbox"/>			
Reception or counter area desks not suitable for the tasks	<input type="checkbox"/>			
Standing workstations unsuitable for users	<input type="checkbox"/>			
General office workstation seating inadequate	<input type="checkbox"/>			
Receptionist chairs inadequate	<input type="checkbox"/>			
Keyboard operator chairs inadequate	<input type="checkbox"/>			
Meeting/board room chairs inadequate	<input type="checkbox"/>			
No headsets provided for frequent telephone work	<input type="checkbox"/>			

**Comments (i.e. when and where it is happening)**

## POSSIBLE SOLUTIONS

- Assess each workstation using workstation checklist in Appendix A.
- Provide adjustable height sitting workstations.
- Design reception or counter areas to reflect the work being done and the level of security necessary.
- Provide adjustable height standing workstations.
- Provide suitable adjustable seating to match the type of work and the floor surfaces, i.e. glides or braked castors on hard floor surfaces.

# APPENDIX C OFFICE SAFETY CHECKLIST



## OFFICE EQUIPMENT AND TOOLS

REFER PAGE 40 OF OFFICEWISE

### Examples of issues which may affect health and safety, productivity and job satisfaction:

- Insufficient, unsuitable, unsafe or inadequate equipment and hand tools provided.
- Sharp implements (such as pen knives and stapler removers) not housed or stored so as to minimise the risk of injury.

ISSUE TICK YES IF THIS ISSUE IS PRESENT	YES	RECOMMENDED SOLUTION	PERSON RESPONSIBLE TO IMPLEMENT SOLUTION	DATE FOR COMPLETION
No electric stapler for tasks that require frequent stapling	<input type="checkbox"/>			
No heavy duty stapler for stapling thick documents	<input type="checkbox"/>			
High frequency staple removal using hand pincer type tool	<input type="checkbox"/>			
Letter openers and other sharp tools exposed	<input type="checkbox"/>			
Frequent use of hand letter openers	<input type="checkbox"/>			
Use of high force to operate hole punch on thick documents	<input type="checkbox"/>			

### Comments (i.e. when and where it is happening)

## POSSIBLE SOLUTIONS

- Provide access to electric stapler and heavy duty stapler.
- Provide lever action staple remover for frequent staple removal.
- Store sharp tools in a manner that does not expose persons to risk of being stabbed or cut.
- Provide letter opening machines for bulk opening of letters.
- Provide powered hole punch or a mechanical punch designed specifically for thick documents.

## STORAGE

REFER PAGE 45 OF OFFICEWISE

### Examples of issues which may affect health and safety, productivity and job satisfaction:

- Insufficient storage space at each workstation.
- Storage space not within easy reach (i.e. between shoulder and mid-thigh height).
- Insufficient space around storage areas to enable easy and safe access.
- Filing cabinets and cupboards unstable when open.

ISSUE TICK YES IF THIS ISSUE IS PRESENT	YES	RECOMMENDED SOLUTION	PERSON RESPONSIBLE TO IMPLEMENT SOLUTION	DATE FOR COMPLETION
Workstation storage inadequate for task	<input type="checkbox"/>			
Insufficient shelving storage	<input type="checkbox"/>			
Heavy items stored outside preferred working zone	<input type="checkbox"/>			
Inadequate general storage	<input type="checkbox"/>			
Unstable filing cabinets and cupboards when open	<input type="checkbox"/>			

### Comments (i.e. when and where it is happening)

## POSSIBLE SOLUTIONS

- Provide additional storage close to workstations.
- Relocate infrequently used items to off-site storage.
- Provide additional shelf storage.
- Relocate heavy items to shelving between knee and shoulder height.
- Provide additional general storage areas.
- Secure filing cabinets and cupboards to the wall or floor to prevent them falling over.
- Provide filing cabinets fitted with locking devices to prevent opening of more than one drawer at a time.

# APPENDIX C OFFICE SAFETY CHECKLIST



## COPYING EQUIPMENT

REFER PAGE 57 OF OFFICEWISE

### Examples of issues which may affect health and safety, productivity and job satisfaction:

- Copier lids not functioning to reduce exposure to intense light.
- Copier not functioning quietly and as quickly as indicated in the specifications for the equipment.
- Self-contained toner cartridges not supplied in a sealed state.
- Safety procedures for use and maintenance not available or regularly reviewed.

ISSUE TICK YES IF THIS ISSUE IS PRESENT	YES	RECOMMENDED SOLUTION	PERSON RESPONSIBLE TO IMPLEMENT SOLUTION	DATE FOR COMPLETION
Copier not functioning correctly	<input type="checkbox"/>			
Printer not functioning correctly	<input type="checkbox"/>			
No safe use or maintenance procedures	<input type="checkbox"/>			
New toner cartridges not supplied in sealed state	<input type="checkbox"/>			
Used toner cartridges not stored in sealed state	<input type="checkbox"/>			
Material Safety Data Sheet (MSDS) on toners not readily available	<input type="checkbox"/>			

### Comments (i.e. when and where it is happening)

## POSSIBLE SOLUTIONS

- Repair or replace equipment.
- Prepare safe use and maintenance procedures.
- Ensure supplier provides toner cartridges in sealed state.
- Store used toner cartridges in sealed container.
- Post copies of current toner MSDSs close to photocopiers.

## HAZARDOUS SUBSTANCES

REFER PAGE 58 OF OFFICEWISE

### Examples of issues which may affect health and safety, productivity and job satisfaction:

- No list of the likely hazardous substances.
- Hazards have not been identified, assessed and controlled.
- Noticeable fumes in the air.
- Work processes that use or generate dust, smoke, fumes or gases.
- Chemicals in the office known to be toxic, corrosive, inflammable or explosive.
- No MSDS and written safe work procedures accessible.
- Inadequate ventilation to remove odours and fumes.
- No training provided to relevant staff.

ISSUE TICK YES IF THIS ISSUE IS PRESENT	YES	RECOMMENDED SOLUTION	PERSON RESPONSIBLE TO IMPLEMENT SOLUTION	DATE FOR COMPLETION
Chemicals, glues, paints and other hazardous substances used without safe work procedures	<input type="checkbox"/>			
Odours and fumes noticeable	<input type="checkbox"/>			
Processes that generate dust, smoke, fumes or gases	<input type="checkbox"/>			
Presence of chemicals or products known to be toxic, corrosive, inflammable or explosive	<input type="checkbox"/>			
Chemicals or products stored or used in areas without adequate ventilation	<input type="checkbox"/>			
No MSDS accessible near the chemicals	<input type="checkbox"/>			
Chemicals training inadequate	<input type="checkbox"/>			

### Comments (i.e. when and where it is happening)

## POSSIBLE SOLUTIONS

- All hazardous substances in use identified, assessed and controlled with documented safe work procedures.
- Eliminate or isolate processes that generate dust, smoke, fumes or gases.
- Eliminate chemicals or products known to be toxic, corrosive, inflammable or explosive or substitute with less hazardous chemicals or products.
- Ensure good ventilation of areas where chemicals and products are stored or used.
- Provide chemical training to all staff required to use chemicals and products.

# APPENDIX C OFFICE SAFETY CHECKLIST



## ELECTRICAL HAZARDS

REFER PAGE 59 OF OFFICEWISE

### Examples of issues which may affect health and safety, productivity and job satisfaction:

- Excessive numbers of power boards and extension cords.
- Electrical leads not tested and tagged on all equipment in accordance with *AS/NZS 3760: In-service safety inspection and testing of electrical equipment*.
- Appliances faulty or not in good order.

ISSUE TICK YES IF THIS ISSUE IS PRESENT	YES	RECOMMENDED SOLUTION	PERSON RESPONSIBLE TO IMPLEMENT SOLUTION	DATE FOR COMPLETION
Excessive numbers of power boards and extension cords	<input type="checkbox"/>			
No inspection and testing of portable electrical leads	<input type="checkbox"/>			
Faulty electrical appliances	<input type="checkbox"/>			
Damaged electrical leads in use	<input type="checkbox"/>			
Use of multiple plugs in one power point	<input type="checkbox"/>			

### Comments (i.e. when and where it is happening)

## POSSIBLE SOLUTIONS

- Install sufficient fixed power points in area.
- Ensure all portable electrical leads regularly tested in accordance with *AS/NZS 3760: In-service safety inspection and testing of electrical equipment*.
- Remove all damaged electrical leads from service.
- Replace multiple plugs with power board provided that there is sufficient capacity in the electrical circuit.

## HOUSEKEEPING

REFER PAGE 59 OF OFFICEWISE

### Examples of issues which may affect health and safety, productivity and job satisfaction:

- Deep carpeted areas in high use trolley areas.
- Wet surfaces near external doors where traffic and weather brings in rain; in kitchen areas, particularly around sinks, urns.
- Wet/polish cleaning of floors during working hours.
- Change of surfaces – carpeted office to polished timber office; sheet vinyl hallway to tiled kitchen; concrete car park to terrazzo office.
- High heeled shoes worn on step or straight ladders or expanded mesh flooring.
- Floor surfaces not properly maintained with damaged tiles, frayed carpet.
- Floors of offices, passageways, corridors and stairways not kept clear.
- Lifts, escalators, etc, not in good working order, e.g. differences in height of lift and floor; damage to escalator comb that may lead to a trip; damage to escalator handrail that may cause injury.
- Sharp corners or edges of furniture and other fittings close to pedestrian traffic areas.

ISSUE TICK YES IF THIS ISSUE IS PRESENT	YES	RECOMMENDED SOLUTION	PERSON RESPONSIBLE TO IMPLEMENT SOLUTION	DATE FOR COMPLETION
Inappropriate floor surfaces	<input type="checkbox"/>			
Areas that may have wet surfaces	<input type="checkbox"/>			
Sudden changes in floor surfaces	<input type="checkbox"/>			
Inadequately maintained floor surfaces	<input type="checkbox"/>			
Poor housekeeping	<input type="checkbox"/>			
Inadequately maintained lifts or escalator	<input type="checkbox"/>			
Inappropriate footwear worn for the task	<input type="checkbox"/>			
Flight of stairs without hand rails	<input type="checkbox"/>			
Ramps that are too steep or with slippery surface	<input type="checkbox"/>			
Hand trolleys used on ramps without edge protection	<input type="checkbox"/>			
No system for removing and repairing damaged or faulty equipment	<input type="checkbox"/>			
Sharp corners of furniture and other fittings	<input type="checkbox"/>			

**Comments (i.e. when and where it is happening)**

### POSSIBLE SOLUTIONS

- Use slip-resistant floor surface in areas where ice, grease or dust create a slipping hazard. Slip resistant door mats at entrances should be secured or large enough to remain in place.
- Hazardous warning signs and procedures for the immediate management of spills.
- Cleaning of floor surfaces outside working hours; or use an effective system to exclude personnel from floors that may be hazardous until dry after cleaning.
- Floor surfaces must be chosen to ensure non-slip conditions when employees move from one floor surface to another; or treat floor surfaces to make the slip resistance of both surfaces similar.
- Ensure suitable footwear is chosen and is worn when doing the task.
- Ensure the slope of a ramp is no more than 1 in 8 and if people in wheelchairs may have to use the ramp, the maximum slope should be 1 in 12 as per AS1428.
- Ramps should be made slip-resistant with foot grips or textured surface.
- Regularly review and maintain uneven, damaged floor surfaces and external access areas.
- Ensure aisles or passageways remain uncluttered at all times and keep work areas tidy.
- Paint a bright strip (highlight) on nosing e.g. steps that are poorly defined visually.
- Where doors open onto stairs a landing with sufficient space for the door to open fully without striking the employee should be provided.
- Eliminate isolated low steps; or if not reasonably practicable, ensure isolated low steps are highlighted.
- Develop a system so that faulty or damaged equipment is taken out of service and replaced or repaired.



## GENERAL HEALTH AND SAFETY ISSUES IN THE OFFICE

REFER PAGE 59 OF OFFICEWISE

### Examples of issues which may affect health and safety, productivity and job satisfaction:

- Stock, materials or displays stored or stacked to a height where ladders or steps are required to access them.
- Chair used as ladder; Straight ladder used on smooth surfaces.
- Step or straight ladder rather than platform ladder used to get items or to put away items into storage.
- Reaching too far to either side; standing on the top rung of a ladder; ladder used on uneven floor surfaces; rung ladder used without being secured; rung ladder used at too shallow or too steep an angle.

ISSUE TICK YES IF THIS ISSUE IS PRESENT	YES	RECOMMENDED SOLUTION	PERSON RESPONSIBLE TO IMPLEMENT SOLUTION	DATE FOR COMPLETION
Storage of stock, materials or displays at height	<input type="checkbox"/>			
Unstable or inappropriate ladders/steps	<input type="checkbox"/>			
Unsafe ladder usage	<input type="checkbox"/>			
<b>Comments (i.e. when and where it is happening)</b>				

## POSSIBLE SOLUTIONS

- Use a safety step to gain access to items at head or shoulder height.
- Ensure appropriate ladder, steps or stairs are used to climb or descend levels.
- Ensure stock, materials or displays are not stacked above shoulder height.
- Ensure ladders and steps are stable or secured when in use.
- Ensure ladders or steps are well maintained with non-slip feet and treads in good condition.
- An item should not be carried while the employee is using a ladder.
- Provide adequate length ladders for tasks (user's waist should not be higher than the top rung of the ladder, i.e. top 3 rungs of a straight ladder and top 2 steps of a step ladder should not be used for the feet).
- Ensure the tops of ladders are tied to a secure structure to prevent slipping or sliding.
- A ladder should be long enough so that when it rests against the upper support, an employee's waist is not higher than the top rung of the ladder or above the rung at which the side rails are resting against the upper support. So the top 3 rungs of a straight ladder or the top 2 steps of a step ladder should not be used for the feet.

# APPENDIX C OFFICE SAFETY CHECKLIST



## SAMPLE DOCUMENT IMPLEMENTING RISK CONTROLS

Where you identified a risk to health and safety in the office it must be eliminated or controlled as far as practicable. An action plan can assist you prioritise your control measures and ensure responsibility for the actions is documented and reviewed.

<b>Location:</b>		<b>Date prepared:</b>			
<b>Persons considering controls</b>	Work area management rep:	Work area H&S rep:			
	Others (employees, consultants)				
<b>Timetable to fix problems</b>					
<b>Short-term (immediately to within a few weeks)</b>					
Task	Action required	Person responsible	Completion date	Reviewed date	Action completed
<b>Medium-term (within a few weeks to a couple of months)</b>					
Task	Action required	Person responsible	Completion date	Reviewed date	Action completed

# APPENDIX D

## REFERENCES AND ADVICE – WHERE TO OBTAIN THEM

---

### APPENDIX D: REFERENCES AND ADVICE – WHERE TO OBTAIN THEM

This appendix is in three parts. The first lists general references, the second lists specific references for each section of the guide, and the third lists organisations that can help with further information.

#### ACTS

##### Victorian

*Occupational Health and Safety Act (2004)*

*Occupational Health and Safety Act Summary (2005)*

##### Commonwealth employees

*Occupational Health and Safety (Commonwealth Employment) Amendment Act (2005)*

#### REGULATIONS

##### Victorian

*Occupational Health and Safety (Manual Handling) Regulations (1999)*

*Occupational Health and Safety (Noise Regulations) (2004)*

*Occupational Health and Safety (Falls) Regulations (2003)*

#### CODES OF PRACTICE

Relevant Victorian and Commonwealth Codes of Practice, Compliance Codes, guidelines, guidance notes and industry-based guides are listed by topic below.

##### 1. Managing occupational health and safety in the office

WorkSafe Victoria, *Information for Employers, Occupational Health and Safety Act 2004, May 2004*

WorkSafe Victoria, *Information for Employees, Occupational Health and Safety Act 2004, May 2004*

WorkSafe Victoria, *Designing Safer Buildings and Structures: a Guide to Section 28 of the Occupational Health and Safety Act 2004*

Comcare Australia, *OHS Risk Management*, incorporating:

- *Taking Control of Occupational Overuse Syndrome: A Pilot Prevention Program (1997)*

Comcare Australia, *Are You Relocating or Closing an Office? (1998)*

National Occupational Health and Safety Commission, *A Guidance Note for the Prevention of Occupational Overuse Syndrome in Keyboard Employment (NOHSC: 3005 (1996))*

Standards Australia, *AS 1885.1: Workplace Injury and Disease Recording (1990)*

Standards Australia, *AS/NZS 4360: 2004 – Risk Management*

Standards Australia, *AS/NZS 4801: 2001 – Occupational Health and Safety Management Systems – Specification with Guidance for Use*

Standards Australia, *AS/NZS 4804: 2001 – Occupational Health and Safety Management Systems – General Guidelines on Principles, Systems and Supporting Techniques*

WorkSafe Victoria, *Manual Handling Code of Practice (2000)*

WorkSafe Victoria, *SafetyMAP: Auditing Occupational Health and Safety Management Systems, 4th edition (1997)*

WorkSafe Victoria, *SafetyMAP Initial Self-Assessment User Guide 4th edition (2001)*

Contact: JAS-ANZ (Phone: (02) 6282 5840) or WorkSafe Victoria (Phone: (03) 9641 1508)

# APPENDIX D

## REFERENCES AND ADVICE – WHERE TO OBTAIN THEM

---

WorkSafe Victoria, *Guidance Note on the Prevention of Bullying and Violence at work (2003)*

WorkSafe Australia, *National Standard for Workplace Injury and Disease Recording (NOHSC: NS 002 (1990))*

### **2. Job design in office work**

#### **Manual handling**

Comcare Australia, *Manual Handling: Reducing Injuries (1995)*

National Occupational Health and Safety Commission, *Core Training Elements for the National Standard for Manual Handling (1995)*

WorkSafe Victoria, *Manual Handling Code of Practice (2000)*

WorkSafe Australia, *Manual Handling National Standard (NOHSC: 1001 (1990))*

#### **Occupational overuse syndrome**

National Occupational Health and Safety Commission, *Guidance Note for the Prevention of Occupational Overuse Syndrome in Keyboard Employment (NOHSC:3005 (1996))*

WorkSafe Australia, *National Code of Practice for the Prevention of Occupational Overuse Syndrome (NOHSC:2013 (1994))*

#### **Stress**

Comcare Australia, *Working Well: An Organisational Approach to Preventing Psychological Injury (Publication 47 (2005))*

Comcare Australia, *Working Well: Steps to Prevent and Manage Psychological Injury – Easy Reference Guide (Publication 56 (2005))*

### **3. Designing a healthy and safe working environment**

#### **Lighting and vision**

Comcare OHS Fact Sheet, *Advice on Approved Code of Practice: interior lighting March 2004*

Standards Australia, *AS 1680.2.1: Interior Lighting: Circulation Spaces and Other General Areas (1993)*

Standards Australia, *AS 1680.2.2: Interior Lighting: office and Screen-based Tasks (1994)*

#### **Noise**

Comcare Australia, *Managing Noise at Work (1995)*

Comcare Australia, *Listen Today, Hear Tomorrow (1995)*

National Occupational Health and Safety Commission, *Core Training Elements for the National Standard for Occupational Noise (1995)*

Standards Australia, *AS 2822: Acoustics: Methods of Assessing and Producing Speech Privacy and Speech Intelligibility (1985)*

Standards Australia, *AS 2107: Acoustics: Recommended Design Sound Levels and Reverberation Times for Building Interiors (2000)*

WorkSafe Victoria, *Occupational Health and Safety (Noise) Regulations (2004)*

WorkSafe Victoria, *Guide for Assessing and Fixing Noise Problems at Work (2005)*

*National Code of Practice for Noise Management and Protection of Hearing at Work (NOHSC: 2009 (2004))*

### ***Thermal comfort and air quality***

Comcare Australia, *Approved Code of Practice on Indoor Air Quality*, incorporating:

- Standards Australia, *AS/NZS 3666: Air Handling and Water Systems of Buildings: Microbial Control, Design, Installation and Commissioning (1995)*
- Standards Australia, *AS/NZS 1668.2: The use of Ventilation and Air Conditioning in Buildings: Ventilation Design (2002)*

Comcare Australia, *Air Conditioning and Thermal Comfort in Australian Public Service Offices: An Information Booklet for Health and Safety Representatives (1995)*

Department of Human Services, *Building (Legionella) Act 2000*

Department of Human Services, *Health (Legionella) Regulations 2001*

WorkSafe Australia, *Office Copying Machines (1989)*

### **4. Office layout, workstations and equipment**

Australian Industrial Relations Commission, *Australian Public Service Home-based Work Interim Award (1994)*

Comcare Australia, *Approved Code of Practice on Visual Display Units*, incorporating:

- Standards Australia, *AS 3590.1: Screen-based Workstations: Visual Display Units (1990)*
- Standards Australia, *AS 1680.2.2: Interior Lighting: Office and Screen-based Tasks (1994)*

Standards Australia, *AS 3590.1: Screen-based Workstations: Visual Display Units (1990)*

Standards Australia, *AS 3590.2: Screen-based Workstations: Workstation Furniture (1990)*

Standards Australia, *AS 3590.3: Screen-based Workstations: Input Devices (1990)*

Standards Australia, *AS/NZS 4438: Height-adjustable Swivel Chairs (1997)*

Standards Australia, *AS/NZS 4442: Office Desks (1997)*

Standards Australia, *AS/NZS 4443: Office Panel Systems: Workstations (1997)*

WorkSafe Australia, *Ergonomic Principles and Checklists for the Selection of Office Furniture and Equipment (1991)*

WorkSafe, *Fitness Ball not Suitable as a Chair (2005)*

### ***Slip, trips and falls***

Occupational Health and Safety (Falls) Regulations 2003

### ***Additional reading***

### **5. Working with computers**

Comcare Australia, *Guidelines for Eyesight Testing and Optical Correction for Visually Demanding Tasks (1994)*

WorkSafe Australia, *Technical Report of the Study Group on Eyesight Testing of Users of Screen-based Equipment (NOHSC: 1004 (1992))*

### ***Radiation***

Australian Radiation Laboratory, *Video Display Terminal Health Concerns and Radiation Emissions: Technical Report (ARL/TRO92)*

# APPENDIX D

## REFERENCES AND ADVICE – WHERE TO OBTAIN THEM

---

### 6. Managing general hazards in the office

#### **Smoking**

Public Service Commission, *Guidelines on Official Conduct of Commonwealth Public Servants (1995), Chapter 18*

Safety Concepts Pty Ltd, *What Everyone Should Know About Smoking in the Workplace (1988)*

WorkSafe Australia, *Guidance Note on Passive Smoking in the Workplace (NOHSC: 3019 (1994))*

#### **Transmissible diseases**

NOHSC, *National Code of Practice for the Control of Work-related Exposure to Hepatitis and HIV (blood-borne) Viruses (NOHSC: (2003))*

#### **Drugs and alcohol**

WorkSafe Victoria, *Alcohol in the Workplace – Developing a Workplace Alcohol Policy (2004)*

#### **First aid**

Comcare Australia, *Approved Code of Practice for First Aid in Commonwealth Workplaces (1999)*

WorkSafe Victoria, *First Aid in the Workplace (Code of Practice No. 18 1995)*

#### **Emergencies in the office**

*Emergency Management Act 1986 (Victoria)*

Ministry for Police and Emergency Services (Victoria), *State Disaster Response Plan (1992)*

Standards Australia, *AS 3745: Emergency Control Organisations and Procedures for Buildings (1995)*

Standards Australia, *AS 3504: Fire Blankets (1995)*

Standards Australia, *AS 1851: Maintenance of Fire Protection Equipment (1995)*

Standards Australia, *MP24: Use of Lifts in Emergencies (1989)*

#### **Photocopiers**

South Australian Department of Labour, *Photocopiers in Workplaces, Safeguard Series No GS31 (1990)*

Workers Health Centre (New South Wales), *Photocopiers – Are They A Health Hazard? Fact Sheet No 8 (1990)*

WorkSafe Australia, *Office Copying Machines (1989)*

#### **Hazardous substances**

Comcare Australia, *Approved Code of Practice on the Control of Hazardous Substances*, incorporating:

- WorkSafe Australia, *Code of Practice for the Control of Workplace Hazardous Substances (NOHSC: 2007 (1994))*
- WorkSafe Australia, *Code of Practice for the Labelling of Workplace Substances (NOHSC: 2012 (1994))*
- WorkSafe Australia, *Code of Practice for the Preparation of Material Safety Data Sheets (NOHSC: 2011 (1994))*

National Occupational Health and Safety Commission, *Guidance Note: List of Designated Hazardous Substances (NOHSC: 1005 (1999))*

WorkSafe Victoria, *Occupational Health and Safety (Hazardous Substances) Regulations (1999) and Code of Practice (2000)*

WorkSafe Australia, *Approved Criteria for Classifying Hazardous Substances (NOHSC: 1008 (1994))*

WorkSafe Australia, *Guidance Note for the Assessment of Health Risks Arising From the Use of Hazardous Substances in the Workplace (NOHSC: 3017 (1994))*

# APPENDIX D

## REFERENCES AND ADVICE – WHERE TO OBTAIN THEM

---

WorkSafe Australia, *Exposure Standards for Atmospheric Contaminants in the Occupational Environment (NOHSC: 1003 (1995))*

WorkSafe Australia, *Guidance for Health Surveillance (NOHSC: 7039 (1995))*

WorkSafe Australia, *Guidance Note for the Control of Workplace Hazardous Substances in the Retail Sector (NOHSC: 3018 (1994))*

### **Early intervention and occupational rehabilitation**

Comcare Australia, *Working Well: Recognition, Resolution and Recovery: Early Intervention to Support Psychological Health and Wellbeing (Publication 46 (2005))*

WorkSafe Australia, *Guidance Note for Best Practice Rehabilitation Management of Occupational Injuries and Disease (NOHSC: 3021 (1995))*

## **WHERE TO OBTAIN REFERENCES AND FURTHER ADVICE FROM EXPERTS**

### **WorkSafe Victoria**

WorkSafe Victoria can provide further information and advice about issues to do with office health and safety. Further information is available through any WorkSafe Victoria office.

Contact telephone numbers for WorkSafe Victoria offices are on the back cover.

### **Unions and employer groups**

A number of trade unions, employer associations and trade and industry associations provide services in occupational health and safety.

### **Consultants**

There are a range of consultants available who can advise on health and safety issues in offices. These include some occupational health and safety consultants, ergonomists, occupational hygienists, lighting and air conditioning consultants and office designers.

- WorkSafe Victoria has a data base of occupational health and safety consultants.
- Ergonomists, occupational hygienists, lighting and air conditioning consultants, office furniture and equipment suppliers and designers are listed in the telephone directories.
- Employer, trade and industry associations and trade unions may be able to advise on suitable consultants.

It is important to choose a consultant who has the skills, knowledge and experience necessary to deal with your problems.

For legislation, codes of practice, books, guidance notes and technical reports, contact the following organisations.

### **Standards Australia**

19–25 Raglan Street  
South Melbourne 3205

Postal address  
Locked Bag 802  
South Melbourne Victoria 3205

Phone (03) 9693 3555  
[www.standards.org.au](http://www.standards.org.au)

# APPENDIX D

## REFERENCES AND ADVICE – WHERE TO OBTAIN THEM

---

### **Comcare Australia (Victorian State Branch)**

Level 2, 121 William Street  
Melbourne 3000

Postal address  
GPO Box 9905  
Melbourne Victoria 3001  
or Canberra ACT 2600

Phone: 1300 366 979  
[www.comcare.gov.au](http://www.comcare.gov.au)

### **Government Info Shop**

190 Queen Street  
Melbourne 3000

Phone: (03) 9670 4224, toll-free 132 447  
[www.mel.infoshop@finance.gov.au](mailto:www.mel.infoshop@finance.gov.au)

### **Information Victoria**

356 Collins Street  
Melbourne 3000

Phone: 1300 366 356  
[www.information.vic.gov.au](http://www.information.vic.gov.au)

### **Office of the Australian Safety and Compensation Council (formerly National Occupational Health and Safety Commission and WorkSafe Australia)**

25 Constitution Avenue  
Canberra City ACT 2601

GPO Box 1577  
Canberra 2601

Phone: (02) 6279 1000  
[www.nohsc.gov.au](http://www.nohsc.gov.au)



# SUBJECT INDEX

- Acoustic shock 43
- AFRDI Standards 36
- Air flow 29, 30, 57
- Air quality 30, 57
  - Diseases 10, 30
- Airborne contaminants 30
  - Smoke 53
  - Ozone 30, 57
- Air conditioning 30, 31
- Air vents 30
- Alcohol 10, 54
- Angle boards 38, 65
- Australian Standards 10
- Bifocals 50
- Bomb threat 54, 56
- Building Block approach 32
- Bullying 13, 15, 17, 18
- Cable housing 37, 52
- Cancer 51
- Cataracts 50
- Chairs 34, 35, 62, 63
  - Adjustable 34
  - Armrests 34, 36, 63
  - Backrests 34, 35, 36, 62
  - Castors 36
  - Executive 35
  - Glides 36
  - High 38
  - Kneeling 35
  - Office 34, 35, 36
  - Purchasing and trialling 36
  - Setting seat height 32, 62
- Checklists 11, 21, 31, 48, 52, 61, 66, 72
- Codes of Practice 9
- Compactus 7, 46
- Computer docking stations 42
- Consultation 2, 4, 10, 11
- Design 32
- Desks 37, 38, 63
  - Freestanding height-adjustable 37
  - Freestanding fixed-height 37
  - Multi-task 37
  - Multi-user 37
  - Selection 37
  - Setting up 63
  - Split 37
  - See workstation design
- Document holders 41, 65
- Draughts 30
- Drawers 32, 46, 63
- Drugs 18, 54
- Electrical safety 59
- Electronic diaries 42
- Electromagnetic radiation 49, 51, 52
- Emergencies 54
- Employee Assistance Programs (EAP) 18
- Epilepsy 51
- Exercises 20, 68
- Exits 19, 33, 56, 58
- Eye 22, 23, 24
  - Damage 25
  - Exercises 71
  - Sight testing 50
  - Strain 25, 38, 50, 51
- Fatigue 16, 19
- Filing cabinets 32, 33, 45, 46
- Fire 54, 56, 59
- First aid 54, 55
- Floor 32
  - Space – primary, secondary and tertiary 32
  - Surfaces 32
- Food hygiene 59
- Footrests 36, 63
- Glide points 40
- Guidance notes 9
- Guidelines for computer users 52
- Hazard 4, 5, 6, 7
  - Identification 5, 6, 8
  - Management 4, 7, 8
  - Mechanical 6, 7
  - Physical 6, 12
  - Psychosocial 13
- Hazardous substances 58
- Health and safety policy 10
- Hierarchy of risk control 4, 5, 7
- Home office 44
- Housekeeping 59
- Injuries 54
- In trays 46, 64
- Job design 12, 17, 18, 61
  - Physical factors 14, 17
  - Psychosocial factors 13
- Keyboard 39, 64
  - Adjustment 39
  - Placement 39
  - Setting up 64
  - Split 37, 39
  - Skills 20
- Laptop computers 42
- Legislation 9
  - Occupational Health and Safety Act 9
  - Regulations 9
  - Codes of Practice 9
  - Compliance Codes 9

# SUBJECT INDEX

---

- Light and lighting 22, 66
  - Contrast 24
  - Flickering 25
  - Glare 24, 66
  - Illuminance levels 23
  - Natural light 25
  - Quality 23
  - Reflections 24, 66
  - Shadows 24
  - Task lamps 24
- Lockers 47
- Manual handling 12, 47, 60, 61
- Material Safety Data Sheets 58
- Mobile phones 43
- Monitor 24, 44, 52
- Monitor stands 42, 65
- Mouse 39, 40, 64
- Muscle strain 12
- Noise 26, 28
  - Disturbing 26, 27, 28
  - Double-glazed windows 28
  - Masking sound or white noise 28
  - Sound absorbent panels 28
  - Speech privacy 27
- Preventing discomfort 40
- Occupational Overuse Syndrome 12
- Occupational rehabilitation 54
- Occupational violence 15, 18, 56
- Off-site work 44
- Ozone 30, 57
- Partitions 28, 33
- Pens 41
- Personal security 15, 56
- Personal protective equipment 5, 7, 8
- Photocopiers 57, 58
- Posture 12, 20, 25, 62, 63, 64, 65, 68, 69, 70
- Pregnancy 51
- Radiation 51
  - Swedish limits 52
- Reach capacity 45
  - Reach sectors 45, 64
- Reception 33, 44
- Recording injuries and incidents 6
- Repetitive Strain Injury 12
- Rest breaks 8, 20
- Risk 2, 5
  - Assessment 5, 7
  - Control 5, 7, 8
  - Control evaluation 8
- SafetyMAP 8
- Screen filters 24, 49
- Shift work 16
- Sick Building Syndrome 30
- Skin disorders 51
- Slips, trips and falls 59
- Smoking 53
- Software 43
- Storage 33, 45
  - Compactus 46
  - Desktop 45
  - Filing cabinets 32, 46
  - Shelving 45
- Stress 13,17
- Task variety 6, 20
- Technical Reports and Guidance Notes 9
- Telephones 40, 43
  - Hands-free 40
  - Teleconferencing 43
- Thermal comfort 29
  - Draughts 30
  - Thermal gradients 30
- Toner 57, 58
- Training 7, 10
- Trolleys 47, 60
- Ventilation 30, 32, 57
- Visual rest 71
- Voice recognition technology 43
- Walkways 33
- Window 24, 30, 66, 71
- Work adjustment periods 20
- Workbench and workstation design 33, 34, 37, 38, 62
  - Adjustability 33, 34
  - Computer and administrative 34
  - Corner workstations 37
  - Drafting workstations 36
  - Flexibility 33
  - Multi-user 37
- Reception 44
- Setting up 62
- Standing-height bench 38

---

## WorkSafe Victoria

### Advisory Service

222 Exhibition Street  
Melbourne 3000

Phone.....03 9641 1444

Toll-free.....1800 136 089

Email.....[info@worksafe.vic.gov.au](mailto:info@worksafe.vic.gov.au)

### Head Office

222 Exhibition Street  
Melbourne 3000

Phone.....03 9641 1555

Toll-free.....1800 136 089

Website.....[worksafe.vic.gov.au](http://worksafe.vic.gov.au)

### Local Offices

Ballarat.....03 5338 4444

Bendigo.....03 5443 8866

Dandenong.....03 8792 9000

Geelong.....03 5226 1200

Melbourne

(628 Bourke Street).....03 9941 0558

Mildura.....03 5021 4001

Mulgrave.....03 9565 9444

Preston.....03 9485 4555

Shepparton.....03 5831 8260

Traralgon.....03 5174 8900

Wangaratta.....03 5721 8588

Warrnambool.....03 5564 3200